

R.E.A.C.T.

Renewable Energy Activities – Choices for Tomorrow

Teacher's Activity Guide for Middle Level Grades 6-8

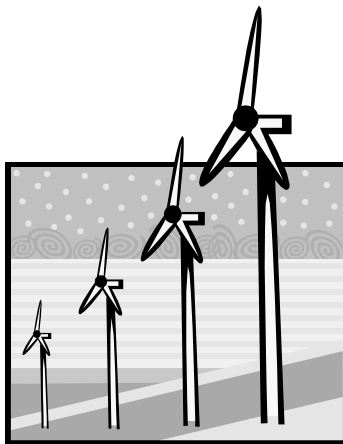

National Renewable Energy Laboratory
Education Programs
1617 Cole Blvd.
Golden, Colorado 80401
Tel: (303) 275-3044
Home page: <http://www.nrel.gov>



ACKNOWLEDGMENTS

The Education Office at NREL would like to thank Dr. James Schreck, Professor of Chemistry and Biochemistry, University of Northern Colorado, for his commitment and hard work in the development of this activity booklet. His expertise was invaluable in producing a final product that attempts to be "user friendly."

It is the goal of the Education Office to make these kits accessible, easy to use, and fun. We want your students to gain, not only an understanding of renewable and nonrenewable energy resources, but a greater confidence in investigating, questioning, and experimenting with scientific ideas.

If you have questions, please call the Education Office at (303) 275-3044 or e-mail: linda_lung@nrel.gov.

TO THE EDUCATOR

This activity booklet was developed by the Education Office at the National Renewable Energy Laboratory. *Users of this booklet should practice appropriate safety guidelines in doing demonstrations or hands-on activities.*

STATE CONTENT STANDARDS

The activities in this booklet address portions of the following guidelines from the Colorado Science Standards.

1.0 Students understand the processes of scientific investigation, and design, conduct, communicate about, and evaluate such investigations.

2.0 Physical Science: Students know and understand common properties, forms, and changes in matter and energy. (Focus: Physics and Chemistry)

2.2 Students know that energy appears in different forms, and can move (be transferred) and change (be transformed).

2.3 Students understand that interactions can produce changes in a system, although the total quantities of matter and energy remain unchanged.

3.2 Students know and understand interrelationships of matter and energy in living systems.

5.0 Students know and understand interrelationships among science, technology, and human activity and how they can affect the world.

ASSESSMENTS/RUBRICS

Teachers are encouraged to use task assessments that will meet the individual needs of students. Assessments should be open-ended, problem-solving activities with some that require recall of content knowledge.

Included in this booklet is a "generic" rubric. This rubric is established as *a guideline for performance*. It is a useful form of self-evaluation because it lets the student know what is expected for high quality work. Harriet Yustein, a teacher from Suffern, New York, states that, "Through experience I have found that the best rubrics come from the children themselves. You should model what you want them to do and then they will discuss exactly what you want from them. That will be their rubric."

CONCEPTS

This activity booklet is designed for middle school students, and is appropriate for discussion of energy concepts at these grade levels. The concepts developed through the activities in this kit include:

- what energy is
- how energy is converted
- renewable technologies: wind and water
- renewable technologies: biomass
- renewable technologies: solar

TEACHING-LEARNING MODEL

Each activity in this booklet has been selected for its renewable energy content and hands-on approach to motivating students. We recommend you read through the activities, choosing those that fit your own curriculum. Or, you may decide to teach these activities in the order presented.

As you prepare to teach these activities, we recommend you read the following information developed by the National Center for the Improvement of Science Education (NCISE). The Teaching-Learning Model (TLM) grew out of teacher enhancement programs developed in national energy laboratories throughout the United States. Teachers were involved in various research assignments that required problem solving and experiment design. As a result of these lab experiences, teachers developed a realistic "scientific method" that they used when doing research. TLM is a compilation of their pattern of thinking.

As you prepare to do these activities, review the steps to TLM. Then choose an appropriate "action" from each step as you work through the activity. Helpful Hints are provided at the beginning of each activity .

TEACHING-LEARNING MODEL

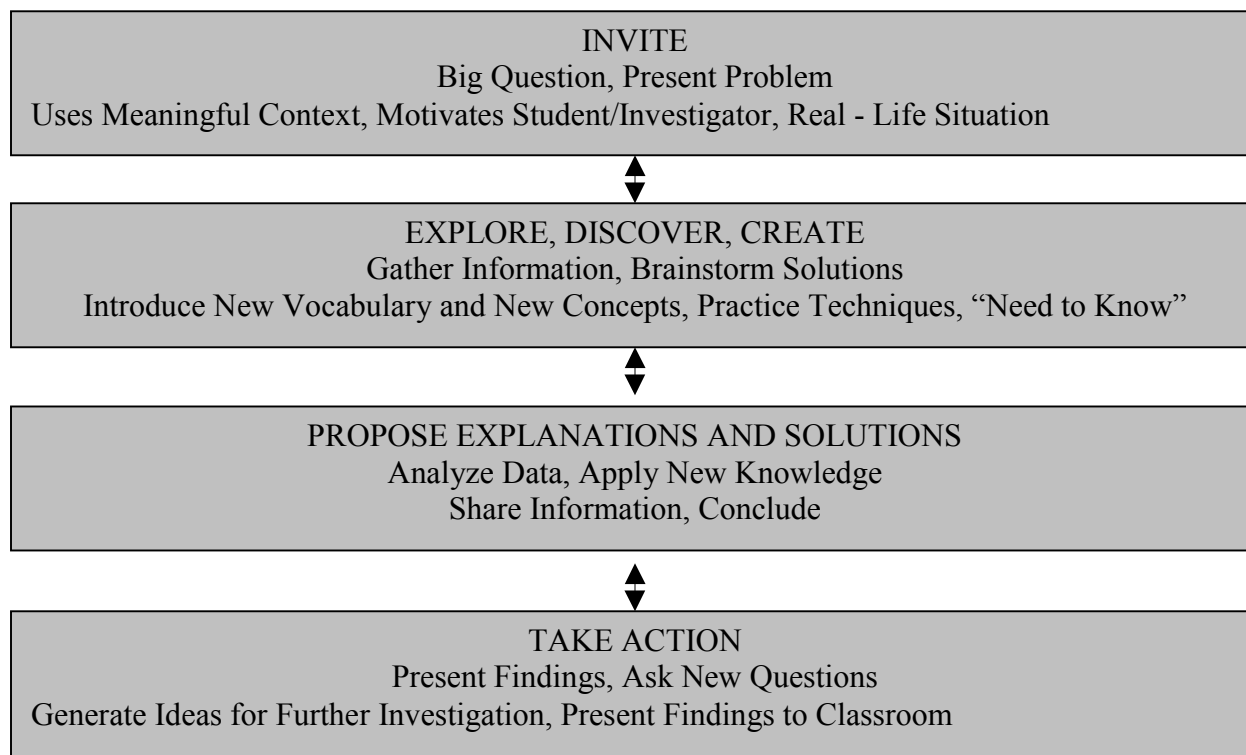

ACTIVITY OUTLINE

The middle school activities in this booklet address energy concepts as follows:

What is Energy?	Activity 1 Energy Detective Activity 2 Renew-a-Bean
Energy Conversions	Activity 3 Energy Conversions Activity 4 Leaf Relay Activity 5 How Can We Generate Electricity?
Renewable Energy: WIND AND WATER	Activity 6 The Answer is Blowing in the Wind Activity 7 Hydropower--Building a "Turbin-ator"
Renewable Energy: BIOMASS	Activity 8 Which Has More Heat? Activity 9 Which Grass Produces More Biomass?
Renewable Energy: SOLAR ENERGY	Activity 10 Solar Cell Power: Series or Parallel? Activity 11 Batch- Type Solar Collectors: Which is Best? Activity 12 Build a Better Solar Greenhouse

RESOURCES

A Teacher's Background is included to help teachers with basic energy concepts, and to help them be more knowledgeable and comfortable in discussing these concepts with students. A generic rubric for teacher- designed student assessments is provided.

Materials found in this curriculum packet were adapted from several sources including:

- *"Energy Conservation Activities for the Classroom K-12," Kentucky Department of Education.
- *"Science Activities in Energy," U.S. Department of Energy, Washington DC.
- *"Award Winning Energy Education Activities for Elementary and High School Teachers," U.S. Department of Energy, Washington DC.
- * "Iowa Developed Energy Activity Sampler K-12," Energy Division Iowa Department of Natural Resources.
- *"Conserve & Renew," California Energy Extension Service.

TEACHER'S BACKGROUND

WHAT IS ENERGY?

Matter is made up of invisibly small particles, occupies space, has mass, and exhibits gravitational attraction. Energy, on the other hand, possesses none of these characteristics. Evidence of energy is everywhere. All you need to do is look for motion, heat, and light.

The nature of energy is very complex, but it is best described by these characteristics:

- energy is the ability to do work,
- work is the application of a force through a distance (e.g., carrying yourself and a loaded back pack up a mountain trail),
- force is that which can put matter into motion or stop it if it is already moving (e.g. , you are stopped at a stop sign and the car behind you doesn't see you stop, and can't stop before colliding with your rear bumper, pushing you into the intersection), and
- motion is a change in distance or direction with time (e.g., making a right hand turn).

Energy can be possessed by an object in two different ways, as kinetic energy and potential energy. If this energy is due to the fact that matter is moving or is in use, it is called kinetic energy. If it is due to the position, structure of matter, or composition, it is called potential energy. Potential energy is stored energy. Table I provided a comparison of kinetic and potential energy.

Table I. Potential and Kinetic Energies.

<i>Potential Energy</i>	<i>Kinetic Energy</i>
Water behind a dam (due to its position)	<i>Falling</i> water
Car parked on a hill (due to its position)	Car <i>rolls</i> down a hill
Wound clock spring	Clock's hands begin to <i>move</i>
Gasoline or sugar (due to their chemical composition)	Energy appears as <i>movement</i> of the car or muscles and as engine or body <i>heat</i>

ARE THERE DIFFERENT FORMS OF ENERGY?

Yes. There are seven **forms** of energy. Just remember the name: MRS CHEN.*

M	Mechanical energy (kinetic-energy); its counterpart is stored energy (potential energy)
R	Radiant energy or sunlight or solar
S	Sound energy
C	Chemical energy
H	Heat energy
E	Electrical energy
N	Nuclear energy

*Thanks to Rick Hanophy, Smiley Middle School, for the use of this model.

"M" represents potential and kinetic energy. They exist in several forms. These are described in

Table 2. Table 2. Energy Forms.

<i>POTENTIAL ENERGY</i>		
<i>Energy Form</i>	<i>Energy Due To</i>	<i>Example</i>
Chemical	Kind and arrangement of small particles	Flashlight battery
Nuclear	Structure of atom's nucleus	Atomic energy
<i>KINETIC ENERGY</i>		
<i>Energy Form</i>	<i>Energy Due To</i>	<i>Example</i>
Heat	Random motion of small particles	Warmth surrounding a car's engine
Sound	Ordered periodic motion of small particles	Sound from a headphone
Radiant	Bundles of photons	Sunlight
Mechanical	Motion of large pieces of matter	Movement of car's wheels

CAN ONE FORM OF ENERGY BE CHANGED INTO ANOTHER FORM?

Yes, and the most common way to observe this change is as heat. In a flashlight battery, the chemical energy in the battery is converted into electrical energy and, finally into light and some heat energy (put your hands over the light source to feel the heat). The **First Law of Thermodynamics** states that energy cannot be created or destroyed; it only changes form.

Other examples of the change of energy into other forms includes:

- When natural gas burns in a home or office furnace, chemical energy stored in the gas is converted into heat energy
- The Sun's radiant energy is converted by plants into chemical energy (a process called photosynthesis).

WHAT ARE THE PRACTICAL SOURCES OF ENERGY?

The practical sources of energy include the fossil fuels, natural gas, petroleum (or oil), and coal. Fossil fuels are referred to as nonrenewable energy sources because, once used, they are gone.

Scientists are exploring the practicality of other sources called renewable energy sources. These include sun, wind, geothermal, water, and biomass. The renewable energy resources are important in long range energy planning because they will not be depleted.

Natural Gas

Sometimes natural gas is confused with gasoline, the fuel in cars. They are not the same. Gasoline is a mixture of liquids, and natural gas is mainly methane and is piped into homes and office buildings where it is used as an energy source for heating, cooking washing, and drying. It is raw material to make other chemicals, and is the cleanest burning fossil fuel. This means it contributes little environmental pollutants when burned.

Petroleum or Oil

This is the black, thick liquid pumped from below the earth's surface wherever you see an oil rig. To make it useful, it is refined. Refining separates the gasoline portion which is used in transportation. Products from the remaining portions include synthetic rubber, detergents, fertilizers, textiles, paints, and pharmaceuticals.

Coal

Coal is the most abundant fossil fuel. It is not a widely used energy source due to the cost of mining and its impurities, which cause pollution (acid rain). There are two ways to mine coal; underground mining and strip mining. Disadvantage to these methods is the environmental change caused in the process. New ways of using coal are being explored, such as liquefaction, in which a product similar to oil is produced.

Solar

The sun is 93 million miles away and yet, this ball of hot gases is the primary source of all energy on earth. In the high temperature of the sun, small atoms of hydrogen are fused, that is, the centers of the two atoms are combined. Fusion releases far greater energy than splitting the atom (fission, see below). Without sunlight, fossil fuels could never have existed. The sun is the supplier of energy which runs the water cycle. The uneven heating of the earth produces wind energy. Solar energy can be used to cook food, heat water and generate electricity. It remains the cleanest energy source and it is renewable. It is the hope for the energy source of the future and scientists at NREL are actively working on ways for solar energy to supply more our energy needs!

Wind

The unequal heating of the earth's surface by the sun produces wind energy, which can be converted into mechanical and electrical energy. For a long time, the energy of wind has been to drive pumps. Today windmills can be connected to electric generators to turn the wind's motion energy into electrical energy, and wind over 8 miles per hour can be used to generate electricity. It is a renewable, but unpredictable, energy source.

Wood

Wood provides U.S. homes and industries as much power as nuclear plants. Burning is the major global source of carbon dioxide in the atmosphere. Worldwide, wood is poor man's oil, providing 50-60% of the people with the barest energy necessities. Roughly half of the earth's forests have disappeared since 1950. Wood is considered a renewable energy source.

Hydroelectric (Falling Water)

When water is collected behind dams on large rivers, it provides a source of energy for the production of electricity. The enormous power of falling water is capable of turning giant turbines. These turbines drive the generators, which produce electricity. The degree of power is determined by the amount of water and the distance it falls. Hydroelectric power plants do not cause pollution, but there are fewer and fewer places to build dams. The environmental problem arises because a dam is typically built on a river creating a lake where land once stood. Water is a renewable energy source.

Ocean Tides

Ocean tides are very powerful forces. To harness the rising and falling of the tides would be an expensive process, but it would be a very important future source for Eastern United States. Perhaps underwater windmills or floating generating stations could utilize this potential energy source to produce electricity.

Geothermal

Geothermal energy refers to the energy deep within the earth. It shows itself in the fountains of boiling water and steam known as geysers. Geothermal energy was generated by the decay of natural radioactive materials within the earth. In addition it is the heat energy remaining within the earth from gravitational formation of the earth. This energy source is not popular in the United States, but Yellowstone has some geysers. Geothermal energy is used to heat some homes, greenhouses, and factories. The actual usable geothermal sites are few, but is considered a renewable energy source.

Biomass

This is garbage! As bacteria decomposes organic waste such as manure, septic tank sludge, food scraps, pond- bottom muck, etc., methane is produced. This methane is the same as natural gas from the ground. There are power plants in the United States, which use methane derived from these organic wastes (mainly manure). Some cities produce electricity by burning garbage in especially designed power plants.

Nuclear Fission

This is splitting of the uranium atom. In the 1930's scientists found that splitting the nucleus of an uranium atom releases a tremendous amount of heat energy. This knowledge was used to make atom bombs. Today, power companies use the heat produced by nuclear fission to produce electricity. Some people think nuclear energy should be our main source of future energy. Other people feel that the dangers are too great from radioactive waste products, meltdowns, and radiation exposure of workers.

Currently the nonrenewable resources supply the majority of our energy needs because we have designed ways to transform their energy on a large scale to meet consumer needs. Regardless of the source of energy, the energy contained in the source is changed into a more useful form -electricity. Electricity is sometimes referred to as a secondary energy source. All the other sources are primary.

In summary, energy sources can be classified as renewable or nonrenewable:

ENERGY

Renewable

1. sun
2. water
3. wood
4. wind
5. biomass
6. geothermal
7. ocean tides

Nonrenewable

1. coal
2. natural gas
3. petroleum
4. nuclear fission

HOW IS ELECTRICITY MADE?

One of the fossil fuels (usually coal) is burned in a power plant to heat water. The hot water turns into steam and forces a machine called a turbine to turn. The turbine powers a generator into electricity which is sent through power lines to provide energy for buildings of all types.

In summary, *coal -hot water -steam -turbine -generator -electricity*.

Electricity can also be made from water behind a dam or by windmills. Falling water or rotating windmill blades will cause the turbine to generate electricity.

Electricity is the most useful form of energy .We take it for granted because it is such an important part of our life style. It makes our everyday endeavors convenient and practical. For example, electricity makes alarm clocks ring in the morning to wake us for school, keeps our food cool in the refrigerator so that cereal tastes good with milk, operates the blow dryer that styles hair, and runs the furnace that blows warm air throughout our homes in the winter to keep us warm.

WHY IS IT IMPORTANT NOT TO WASTE ELECTRICITY?

The conversion of energy from one form to another is covered by a natural law -the Law of Conservation of Energy. This law states that energy can be neither created nor destroyed, it can only be changed from one form to another. This change, however, is one of quantity, not quality .As energy does work, it changes from higher (more concentrated) form of energy to a lower form of energy .For example, of the electrical energy that goes into a typical light bulb, 5% becomes light, the other 95% of the electrical energy is lost as heat. In another example, the chemical energy of gasoline is converted into heat energy in an automobile. A small portion (10%) is converted into mechanical energy that moves the car. The remaining portion (90%) is lost to the environment. You notice this when you stand near an idling car's engine and feel the heat. This concept helps explain why it is important to save (conserve) energy.

HOW CAN WE SAVE ENERGY?

Energy saved is energy gained for another day! Saving energy will cut down on pollution and help our fossil fuels last longer, at least, until renewable energy sources become more practical.

Conservation is the least expensive source of energy available today. Every bit of electricity that is not used to light a room that no one is in, could be used to operate a computer. Power companies have found that mining this kind of wasted energy is often more profitable than generating more energy. The amount of energy that a utility can get its users to save can be sold to other users; incentive programs for saving energy turn out to be profitable to the utility companies. Because of peak-use problems, the utility must have enough energy available to satisfy the needs of all users at peak hours. This often means building an entire power plant (or more) just to cover the demand over a 2-4 hour portion of the day. When everyone conserves energy, the utility can meet peak demand without a new plant, and the building and maintenance expenses that it would incur. Finding a way to do more with less, benefits everyone.

Consumers can actively participate in energy conservation through recycling. Some communities have recycling centers and perhaps your school has a site recycling center. Often recycling centers provide containers for gathered materials, handle all the pick-up, and even supply educational materials to boot!

Citizens need to realize that each and every one of us does make a difference. The solution to energy problems will be solved by individuals. While it may seem nebulous we are the ones who need to pass laws or quit polluting, it will be us who will write letters to, and cast votes for, the lawmakers. Likewise it will be individuals who ride the bus or a bike, instead of driving our own cars. The sum of our individual, daily decisions determines the net outcome of the world's energy use. We want to encourage an honest effort.

What is Energy?

Activity 1: Energy Detective

Activity 2: Renew-a-Bean

Activity 1 ENERGY DETECTIVE

CONCEPT Energy is around us everyday, but "What is Energy?".

GOAL Students will look for energy, collecting "energy evidence," and then come up with their own definition of energy.

MATERIALS Copies of Detective Data Sheet, copies of clues

HELPFUL HINTS USING TLM: Invite: Students create a word splash with energy terms they are already familiar with; make small posters of the word splashes. Explore. Discover. Propose Explanations: Follow the Activity directions below. Ask New Questions: see below.

ACTIVITY

1. Give each student group a copy of the Detective Data Sheet and a copy of the clues. Point out that their goal is to search for the answer to "What is energy?"
2. Based on the clues given in the hand-out, students go in search of evidence that will help them find the answer.
3. Once they have written each clue onto their Data Sheet, have each group come up with a definition.
4. Have each group share their definition with the rest of the class.

ASK NEW QUESTIONS

1. Discuss with students: Can you feel energy? (Heat waves or energy in wind can move us around on a windy day or cause a sailboat to skip across a lake.) Can you see energy? (Yes, sunlight.) Can you hear energy?
2. Have students look up the definition of energy in the dictionary (the capacity for vigorous activity; available power) and compare with the physics definition (the ability to do work). Discuss how these definitions compare with the definition students came up with.
3. Have students make up a list of clues that they can find at home that support the definition, "Energy is the ability to do work." (Examples: electricity causes the light bulbs to glow and get hot, sunlight causes plants to follow it, running water causes left over food to be rinsed from the plate when held under it, etc.)

DETECTIVE DATA SHEET



CLUES

- 1. Energy can make things change.
- 2. Heat comes from energy.
- 3. Movement comes from energy.

EVIDENCE

We know that energy was here because.....	Energy Source (sun? wind? electricity? other?)

REPORT FROM THE
“

DETECTIVE AGENCY”

After you have collected energy evidence, have each person in your group make up a definition for energy. Write definitions in the spaces below. Next, have your whole group agree on one definition and write it at the bottom of the page.

<u>DETECTIVES' NAME</u>	<u>DEFINITION OF ENERGY</u>

GROUP ANSWER: WHAT IS ENERGY?

EXTRA CLUES FOR PUZZLED DETECTIVES

1. Electrical and solar energy give us light.
2. Sun energy grows our food.
3. Lightning is a natural form of electrical energy.
4. Gasoline, made from crude oil, gives us energy to make cars go.
5. Energy heats our homes and school.
6. Energy keeps our refrigerator cold.
7. Sailboats need wind energy.

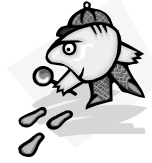

EXTRA CLUES FOR PUZZLED DETECTIVES

1. Electrical and solar energy give us light.
2. Sun energy grows our food.
3. Lightning is a natural form of electrical energy.
4. Gasoline, made from crude oil, gives us energy to make cars go.
5. Energy heats our homes and school.
6. Energy keeps our refrigerator cold.
7. Sailboats need wind energy.

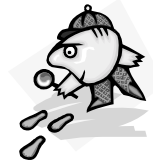

EXTRA CLUES FOR PUZZLED DETECTIVES

1. Electrical and solar energy give us light.
2. Sun energy grows our food.
3. Lightning is a natural form of electrical energy.
4. Gasoline, made from crude oil, gives us energy to make cars go.
5. Energy heats our homes and school.
6. Energy keeps our refrigerator cold.
7. Sailboats need wind energy.

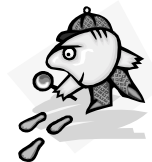

Activity 2 RENEW-A-BEAN

CONCEPT Students will increase their understanding of the eventual depletion of nonrenewable resources, the effect of changing rates of use on the future, the role of conservation and the need to develop renewable resources.

GOAL Beans will be used to represent renewable and nonrenewable energy in a simulation where students will understand how, over several years, nonrenewable resources will be depleted.

MATERIALS 1 open container for every 2 students, lots!! of beans--92% one color; 8% another color (i.e. pinto and garbanzo beans or peanuts and almonds; whatever combinations you use, be sure to maintain the 92:8 ratio to represent the ratio of nonrenewable to renewable energy consumption in the U.S.) Renewables Data Sheet, Draw Chart, blindfolds.

HELPFUL HINTS USING TLM Invite: Ask students what renewable/nonrenewable means; have students calculate how many beans go into the jars if they are given 200 beans and 92% must be of one kind; ask what would happen if they filled the pop machine only once at the beginning of the school year...how long would it last? Explore. Discover. Ask New Questions: see below.

BACKGROUND

Prediction of how long various energy resources will last is risky at best. In the early 1970's, it was predicted that we would run out of natural gas by the late 1980's! In the 1950's, utilities predicted California would need a nuclear power plant every 10 miles along their coastline to meet their electrical energy needs. It is important to know whether a prediction assumes a constant rate of use or a changing rate. It is also important to know whether a rate assumes that more resources will be found or it assumes use of only known reserves. It is also important to consider if foreign resources are included.

The point of this activity is not so much to show the actual numbers, but rather that nonrenewable resources will be depleted and that conservation (reduction of use/waste) together with the development of renewable resources can extend the availability of nonrenewables. It may help you to check the definitions of renewable and nonrenewable in the glossary. The "Draw Chart" on the following pages tells you how many beans to draw if you want to adapt for changes in rate of energy use. For example, if use remains constant from year to year, each person draws 10 beans. If you want to simulate a 4% per year increase in energy use, you go to the column marked 4% per year. Students will predict how many years the energy supply will last, then fill in the number of beans left after each "year." Be sure to look the chart over before you begin so you understand the procedure.

ACTIVITY

1. Divide students into pairs and have them fill an open container with exactly 100 beans: 92% of one kind; 8% of another.
2. Hand out and discuss the Renewables Data Sheet. (Explain that more recent information tells us that the total renewable energy percentage has changed from 7% to 8%.)
3. Explain to students that because the U.S. depends on nonrenewable energy and because the human population is growing (thereby demanding more energy), we face the eventual depletion of this resource. But when? It all depends on how quickly and how much we use energy. If all our energy were *renewable*,

we wouldn't have a problem...there would always be energy. This simulation will show the conditions that affect the depletion of nonrenewable resources. Students will experiment with these conditions to see how long they can extend the use of energy resources.

4. Hand out and explain the Draw Chart. All students should do the first trial together to get the idea of the simulation. Have one student in each pair put on the blindfold. This represents a population that is using energy without thinking about whether it is renewable or nonrenewable. When a student takes beans from the container, they won't be making a conscious choice between renewable or nonrenewable.

5. Review the rules. Explain that the first trial will be based on a population that is using energy at a constant rate. In other words, there is no growth in population and they use the same units of energy from one year to the next. Have students predict how many "years" it will take to deplete the beans in the container. Record it on the Data Chart #1.

6. Begin the activity, reminding students that any renewable beans pulled from the container can be replaced and counted for that year. Continue until only renewable beans are left in the container. Calculate percentages of renewables and nonrenewables that remain after each drawing.

7. Record the number of years it took to deplete all nonrenewable beans. Compare to predictions.

8. Remove blindfolds. Refer students to Data Chart #2. The first two rows represent populations with varying degrees of energy consumption. These would be populations much like ours in the U.S. and other "developed" nations. Countries with a high standard of living consume much more energy than developing, or third world nations. Look at the number of cars we drive, the plastic we use, and the fuel we use to heat/air condition our homes. All this energy consumption is primarily from nonrenewable resources. Remind students, however, that the "consumption" of beans and the years it takes to empty the container are only representative. It doesn't mean we'll run out of energy in 7 or 15 years. *The simulation is designed to show how quickly a growing consumption level can deplete a resource.* You may want to change the time units to reflect a more realistic picture, i.e. each box representing every 5 or 10 years.

9. Now, the other student in the pair is blindfolded. Replace all the beans. Have students choose Data Chart #2 or #3. Repeat the same procedure as above. Be sure they predict before starting.

10. At the conclusion of the second round, discuss again the time it takes to deplete a resource when consumption levels increase. This represents an increasing population. More people place more demands on fewer resources.

11. At this point, tell students to design a way to extend the use of energy resources for as long as possible. The rules remain the same, however. Students are blindfolded, and they must begin by removing 10 beans. They are to establish a rate of consumption that will last longer than either of their previous trials. Have them record their trials in the remaining data boxes. (They should run at least two trials.)

12. When finished, discuss methods used to extend the energy resources, both renewable and nonrenewable. Have students write a conclusion.

ASK NEW QUESTIONS

13. What kind of energy will people be using in the future? Why?
14. Why don't people use more renewable energy now?
15. Are there reasons to use more renewables now rather than wait until the nonrenewables run out?

RENEWABLES DATA SHEET

The United States derives approximately 97% of its total energy from nonrenewables sources. About 3% of our energy comes from renewable resources. From 1986 to 1988 energy consumption increased by 12%.

PIE GRAPH OF ACTUAL CONSUMPTION BREAKDOWN
(1988 figures)

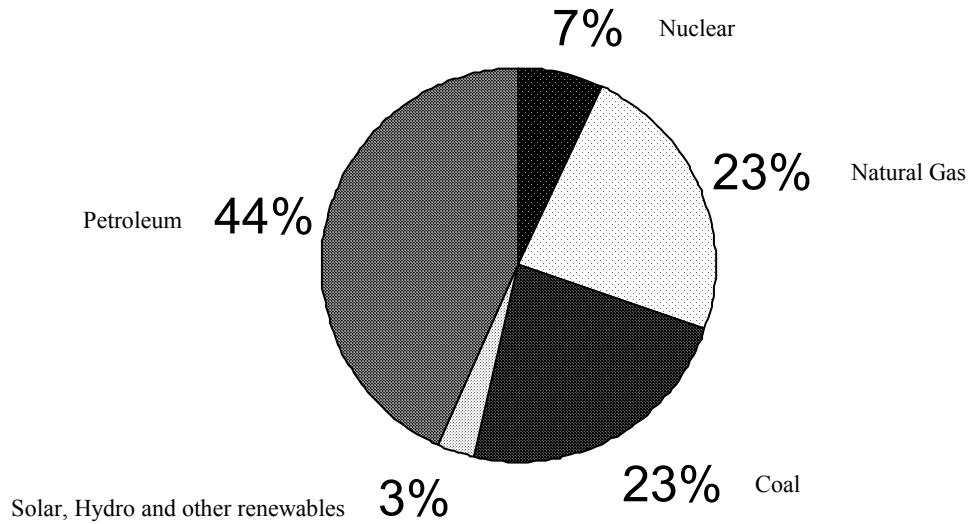

(note: these figures do not include direct solar-gain heating and lighting, which is a major energy source).

Energy Conversions

Activity 3: Energy Conversions

Activity 4: Leaf Relay

Activity 5: How Can We Generate Electricity?

Activity 3 **ENERGY CONVERSIONS**

CONCEPT Energy cannot be created or destroyed. It can only change forms.

GOAL Students will use sensory experiences to create an energy conversion grid.

MATERIALS Solar cell, radiometer, light bulb, battery, electric motor, Wintergreen Lifesavers™.

HELPFUL HINTS USING TLM This activity was originally written using TLM. It should give you an idea of how the scientific method can be used to discover energy conversions.

ACTIVITY

INVITE

1. Begin by asking students to name some examples of energy forms. Remind them about MRS CHEN : mechanical, radiant, sound, chemical, heat, electrical, and nuclear (see Teacher's Background).

2. Explain that energy is useful to people when we can "turn it into" some other kind of energy. For example, electricity is useful when we can use it to light a bulb. Food energy, like a candy bar, is useful when we eat it and let our stomach digest it so we can move.

BRAINSTORM IDEAS PRACTICE TECHNIQUES

3. Hand out "Energy Changes" worksheet.

4. Point out that the worksheet has three of the energy forms that were just talked about. Tell them that you are going to demonstrate some ways that energy changes into a different kind of energy. Students are to figure out into which box the demonstration belongs. The chart, when completed, will look something like the one below:

LIGHT	ELECTRICITY	MOTION
	SOLAR CELL	RADIOMETER; PUPILS DILATING WHEN LIGHTS ARE TURNED ON; PLANTS MOVING WITH THE SUN (CALLED PHOTOTROPISM)
LIGHT BULB		ELECTRIC MOTOR HOOKED TO BATTERY
LIFE SAVERS	STATIC (SPARKS)	

APPLY NEW KNOWLEDGE

5. Go in any order using the following steps as guidelines:

SOLAR CELL: Explain that the sunlight strikes the solar panel which creates electricity.

BULB: Electricity flows to the filaments in the bulb causing them to glow.

ELECTRIC MOTOR: When hooked to a battery, the electricity causes the shaft to spin.

LIFESAVERS SPARKS: Give each student a lifesaver. Turn out the lights. The darker the room the better. As students crunch down on the lifesaver (motion), it makes a spark, (light).

STATIC ELECTRICITY: If your room has a rug, you can demonstrate this more easily. Have a student take off his/her shoes and scoot their feet across the rug. Have them touch a metal object like a desk or pencil sharpener to illustrate static charge.

RADIOMETER: When light strikes the wings of the radiometer, it transfers heat to each one--but not to the same degree. The lighter wing reflects the rays, and the dark wing absorbs the rays. When

freely moving particles of air inside the radiometer strike the light colored wings, they take on very little energy and do not bounce off very fast. (Remind students that black t-shirts on a hot day are warmer than a white t-shirt. NOTE: This will be demonstrated in Activity 11.) The hotter something is, the more the particles that make up the object move around.) But, when particles strike the dark wings, they take on a great deal of energy and "kick" away at terrific speed. The result is the movement of the wings in a circle from black to white.

PHOTOTROPISM: Plants move throughout the day to receive light energy. Observe a flowering plant in the morning as it sits in a windowsill. Observe it again in the afternoon and notice how the plant has changed position relative to the sun. Another example is to turn out the lights in the classroom. Have students form pairs and ask them to look at the pupils of the eyes of their partner. Let the room remain dark for 2 or 3 minutes. Then, count to 3 and turn the lights on. Students should see a shrinking of the pupil in their partner's eyes. This is a more abstract example of light energy creating motion (in the eye).

GENERATE IDEAS FOR FURTHER INVESTIGATION

6. Challenge students to come up with ideas of their own using the second table on their worksheet.

Name _____

ENERGY CHANGES

Changes to →

	LIGHT	ELECTRICITY	MOTION
LIGHT			
ELECTRICITY			
MOTION			

Name _____

HERE ARE SOME OF MY OWN ENERGY CHANGES...

Changes to

The diagram shows a 3x3 grid. The top-left cell is shaded gray. An arrow points to this cell from the left. The middle-right cell is also shaded gray. The bottom-right cell is shaded gray. The other four cells are white.

Activity 4 LEAF RELAY

CONCEPT Energy moves through food chains.

GOAL Students will learn how energy is "lost" when transferred from one system to another.

MATERIALS Enough dry leaves or popcorn for each group of five to have an armful, handful. (You can also use handfuls of sand, beans or Styrofoam@ packing peanuts, or anything else you can find in quantity ,) an open, fairly flat area.

HELPFUL HINTS USING TLM This activity was originally written using TLM. It should give you an idea of how the scientific method can be used to discover energy movement through a food chain.

ACTIVITY

INVITE

1. Introduce students to a simple food chain by putting an example on the chalkboard. Example: sun-grass- sheep; explain that the sun provides energy for grass to grow and the grass provides energy [food] for sheep. OR, sun --> plants --> herbivores --> carnivores --> humans (unless vegetarian!)

DISCOVER/INTRODUCE NEW CONCEPTS

2. Discuss the following points:

- the sun gives off energy that is used by plants
- however, the plants don't use all the energy the sun produces (only 2% is used by plants)
- animals eat plants to get their energy
- however, not all of the energy that was captured by the plant is still in the plant since it had to use some for its own growth and reproduction
- with each transfer of energy, some is "lost" to the process of staying alive

It takes energy to get energy!

CREATE (a food chain) AND APPLY NEW KNOWLEDGE

3. Place the pile of leaves at one end of the site in a pile. Form teams of five students.

4. Have each team line up in a parallel line, with 2 to 3 feet separating each person, and several yards separating each group. The teams should be lined up about 100 yards away from the "energy pile."

Having groups in a large circle surrounding the "pile" of energy allows everyone to see what is happening, but it has to be big!

5. Assign one of the following roles to each student: The first person in line will be the sun; the second, a plant; the third, a herbivore; fourth, a carnivore; and fifth, a human.

6. Have each player, except the sun, mark their spots. Have the suns stand behind the "energy pile" facing their group.

7. Explain that the sun provides the energy needed in each of the food chains. Have the suns scoop up as many leaves as they can hold in their arms.

8. At the "go" signal, the suns race to the plants who (gently) grab as much of the suns' energy as they can.
9. The plants pivot (they do not run), and the herbivores race up to grab as much energy as they can hold. The herbivores return to their spot. As soon as the herbivores return to their spot, the carnivores run up and capture the energy from the herbivores. Continue with the humans. When the humans return to their spot, have them raise the remaining energy above their heads to signal that they are through.

GENERATE IDEAS FOR FURTHER INVESTIGATIONS

10. Look on the ground. What happened to the energy during transport and transfer? Compare the amount held by the first and last person. If there were fewer transfers, how much energy would the last person have? How could we make fewer transfers in obtaining energy in our lives? Take out the carnivore stage and compare the amount of energy left over.
11. Introduce environmental disasters like pesticides, floods, or oil spills at one stage. Have the students immediately drop half the leaves they are carrying. This represents the damage and the lessened energy taken up or transferred. Discuss the effects of having less energy for the food chain and survival problems.

Activity 5 **HOW CAN WE GENERATE ELECTRICITY?**

CONCEPT To understand the importance of renewable energy, students will learn how electricity is made.

GOAL Students will realize that to make electricity, something has to "turn the turbine." (Examples: steam from burning coal, oil, or heating from sunlight (solar-thermal); or falling water; or wind; etc.)

MATERIALS For each group of students, 100 cm of bare copper wire; bar magnet; electric meter (i.e., galvanometer or milliammeter, hollow tube such as a toilet paper roll; student sheet, "How Can You Make Electricity With a Magnet?", and Energy Sources that Turn the Turbine.

HELPFUL HINTS USING TLM Invite: Ask students where the electricity comes from to light the lights in the room, to run the overhead projector, to run the stove, refrigerator, etc. Write key vocabulary words on the board as they use them. Discover. Create: see below.

BACKGROUND

Most electricity is commercially produced using large generators. The generator consists of two parts: the armature, which is a large coil of wire, and magnets, which are usually electromagnets. By moving the coil of wire through the field of the magnets, a current (a flow of electrons) is induced (produced in the wire).

It does not matter whether the coil of wire moves through the magnetic field or whether the magnetic field moves over the wire. The current is always produced in the wire.

As you can see, something has to turn the coil or the magnet. Without energy to do that turning, no electricity can be produced. In an electric generating plant, that energy usually comes from a large windmill-type apparatus called a turbine. The turbine has many blades attached to a shaft.

The turbine is usually spun by hot, expanding steam from a boiler. And the steam is produced by burning fossil fuels or using a nuclear reaction to heat water. However, running water (hydropower) can also be used to spin a turbine. So can wind.

When the turbine turns, its shaft turns. The shaft is attached either to the armature (coils) or to the magnet, and when it turns, it generates electricity.

In order for the current to flow, there must be a complete circuit connected to the wire that breaks the magnetic field. In other words, the end and the beginning of the wire are connected, making a complete loop. The electrical current that is produced is a flow of electrons, in the wire, which can be utilized in various ways. If the end and the beginning of the wire are connected through a radio, for example, the radio will play.

ACTIVITY

1. Break students into groups of 2 or 3. Hand out the lab sheet: "How Can you Make Electricity With a Magnet?"

2. As students work through the activity, introduce the idea that an electric current is a flow of electrons. A magnet can pull tacks or nails, it can also pull electrons.
3. Also ask students: "Do you suppose it makes any difference if we move the magnet in different directions?" Have them try it. The largest current will be produced when the magnet moves perpendicular to the coils.
4. Also ask students: "Are there any other things you can think of that might change the amount of current produced?"
5. Once students have completed the worksheet questions, ask them to construct a turbine generator using some form of renewable energy (perhaps wind or water) to do the turning. Hand out "Energy Sources that Turn the Turbine" as a guide for this activity.

How can you make electricity with a magnet?

Of course you know how a magnet can pick up small metal objects. You can actually make a tack jump to the magnet by holding them close together.

Magnetism is a form of energy. It can push or pull things. It can even push or pull some of the tiny particles that make up matter: electrons. And when you push or pull electrons, you get electricity.

Let's try making electricity with a magnet.

MATERIALS

- 100 cm of bare copper wire
- 1 bar magnet
- 1 electric meter
- 1 cardboard tube

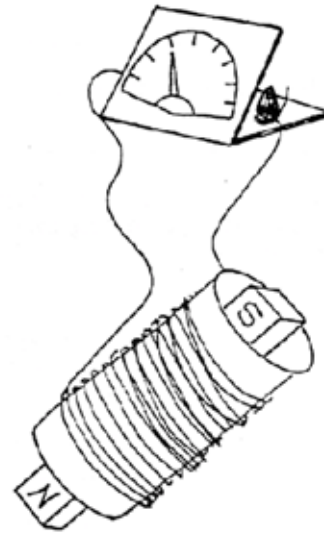

STEPS

1. Wind the wire around the tube about 20 times
2. Connect both ends of the wire to the meter, as shown by your teacher.
3. Take the magnet and move it near the coil but not through it. Observe the meter.
4. Move the magnet in various directions around the coil.
5. Move the magnet through the coil, back and forth. Make more than one trial doing this. Try moving the magnet at different speeds. Move the coil over the magnet, keeping the magnet still.

Now answer the questions below:

1. In which step did the meter move the most?

2. When the meter made the greatest movement, in what direction were you moving the magnet?

3. Was there a difference between moving the magnet through the coil, or moving the coil over the magnet?

4. Was there a difference when you moved the magnet faster?

5. The lines of force on a magnet would look something like this (if we could see them).

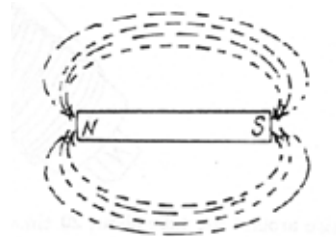

What happened to those force lines when you moved the magnet inside the coil?

6. Can you figure out some way that you could make the magnet spin really fast inside the coil?

Name _____

ENERGY SOURCES THAT TURN THE TURBINE

DIRECTIONS: For each row of three pictures, draw in the missing part.

Contact: National Energy Foundation
3676 California Ave.
Suite A117
Salt Lake City, UT 84104
(801) 908-5800
<http://www.nef1.org>

Geothermal energy → Steam

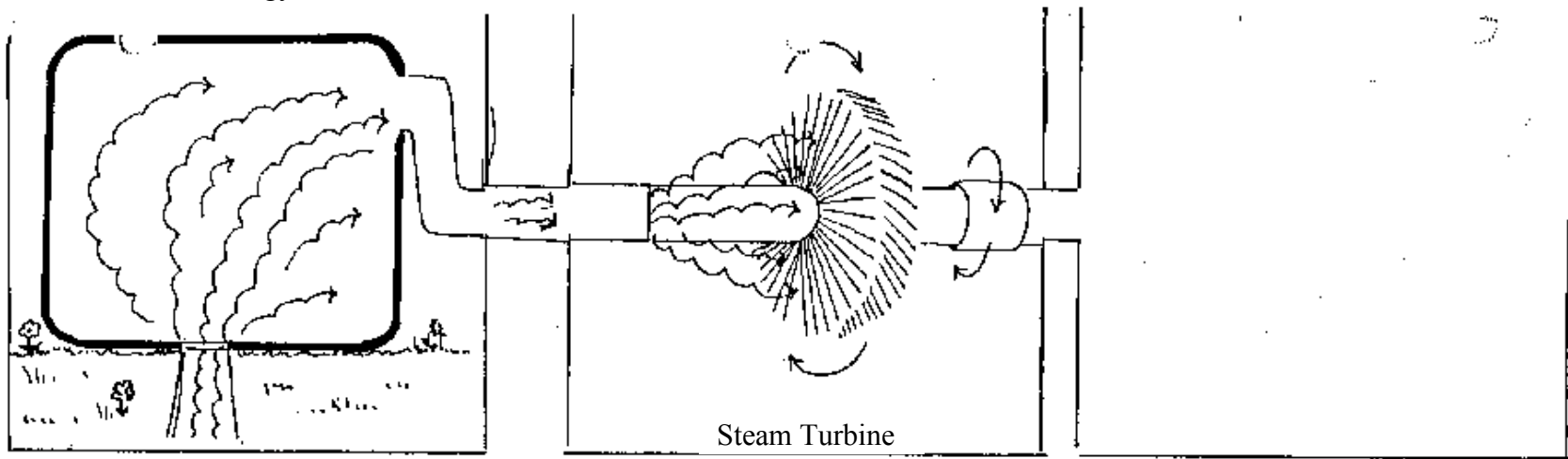

We get steam from beneath the earth's surface to produce a small amount of electricity.

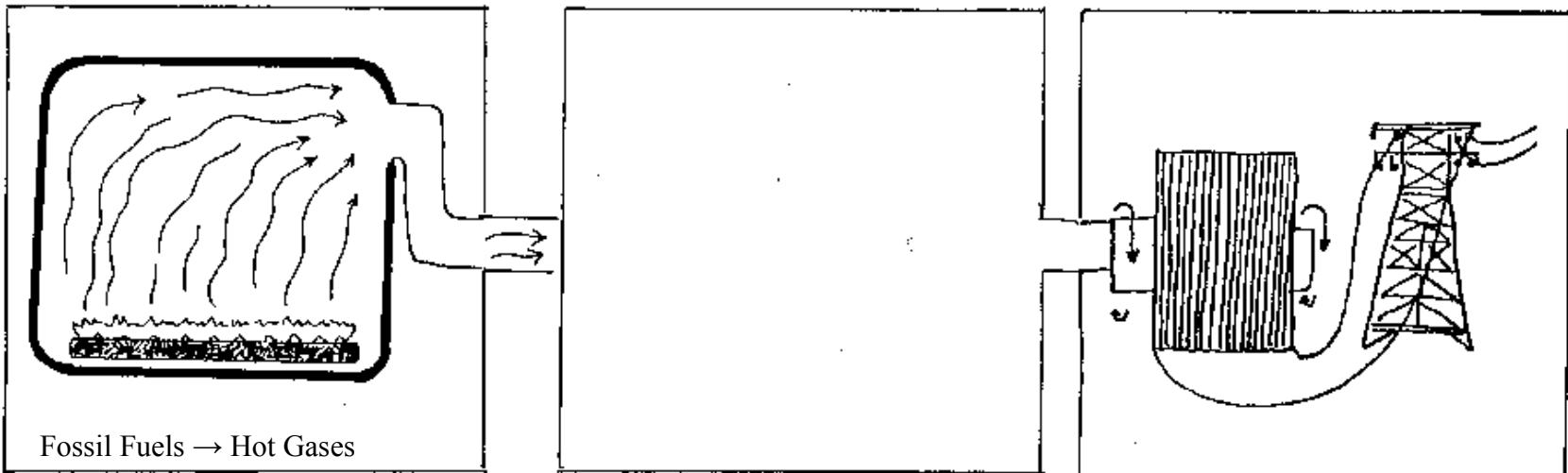

Fossil Fuels → Hot Gases

We burn coal, oil, or natural gas to make hot gases to produce electricity.

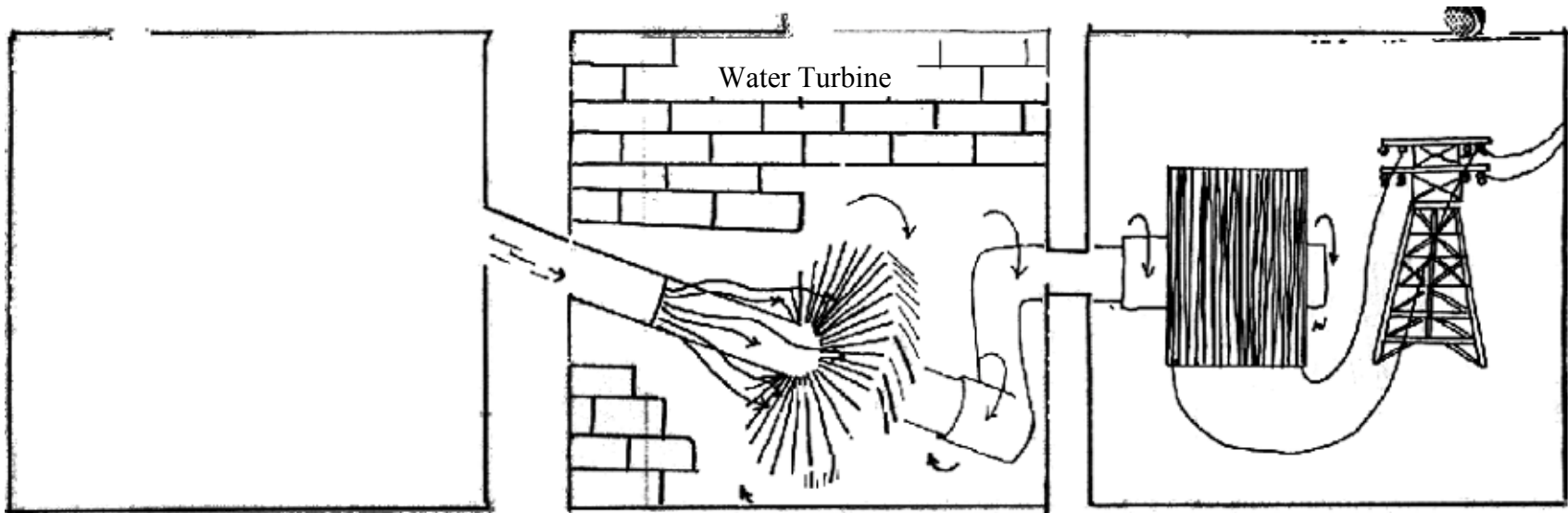

We dam up water to turn turbines to make 13% of our electricity.

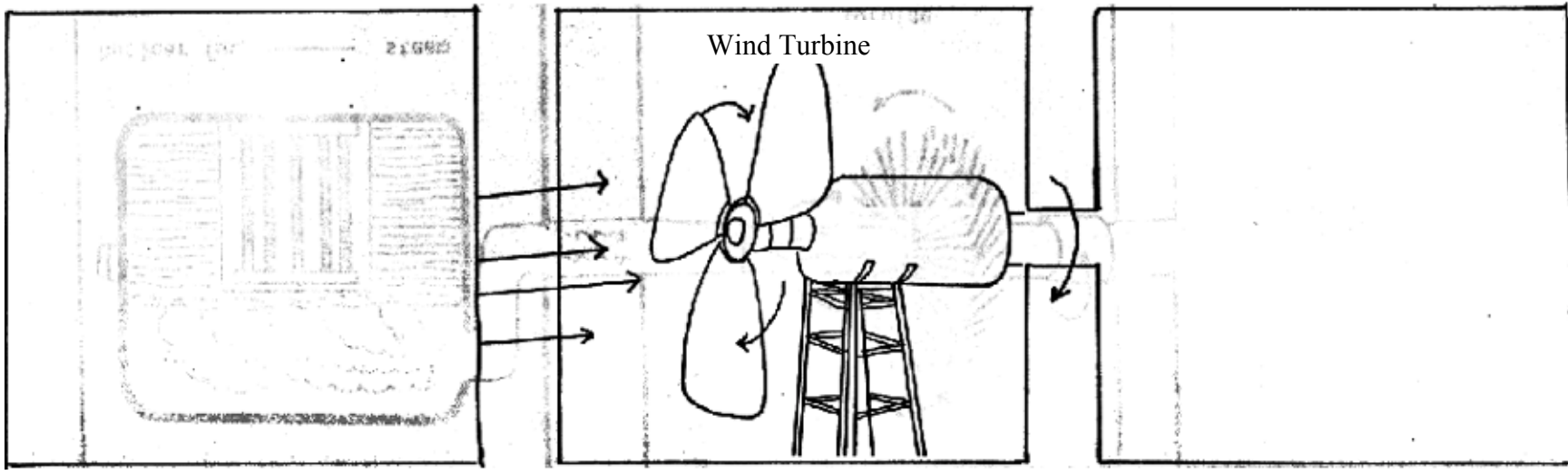

We use the wind to turn turbines to produce a very small amount of electricity.

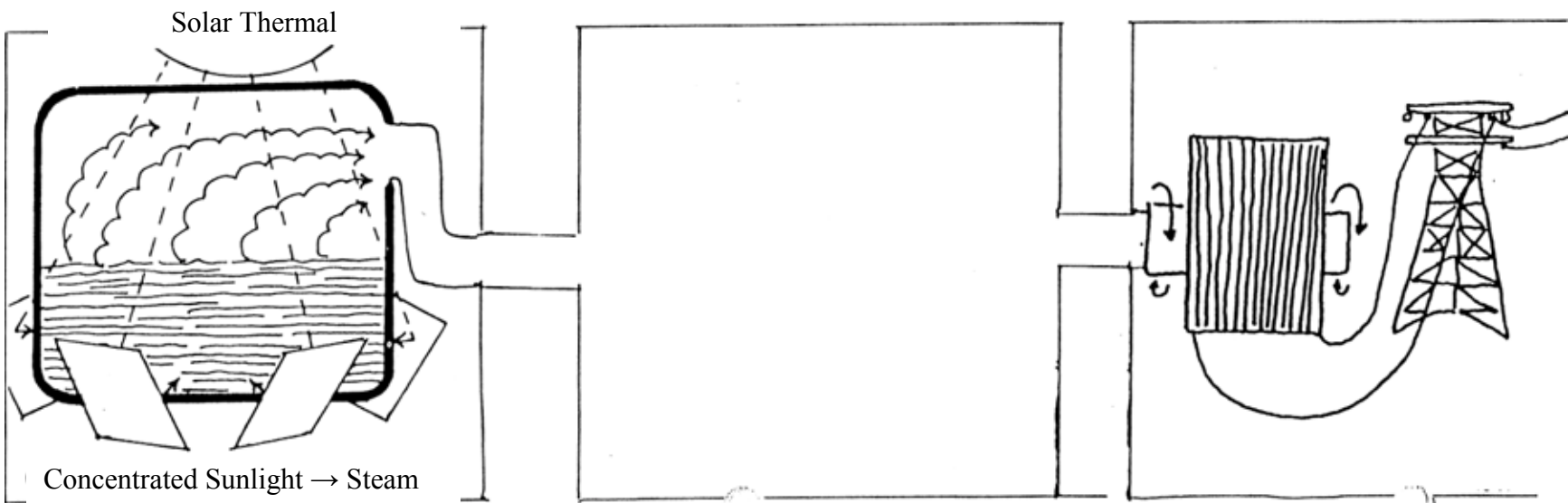
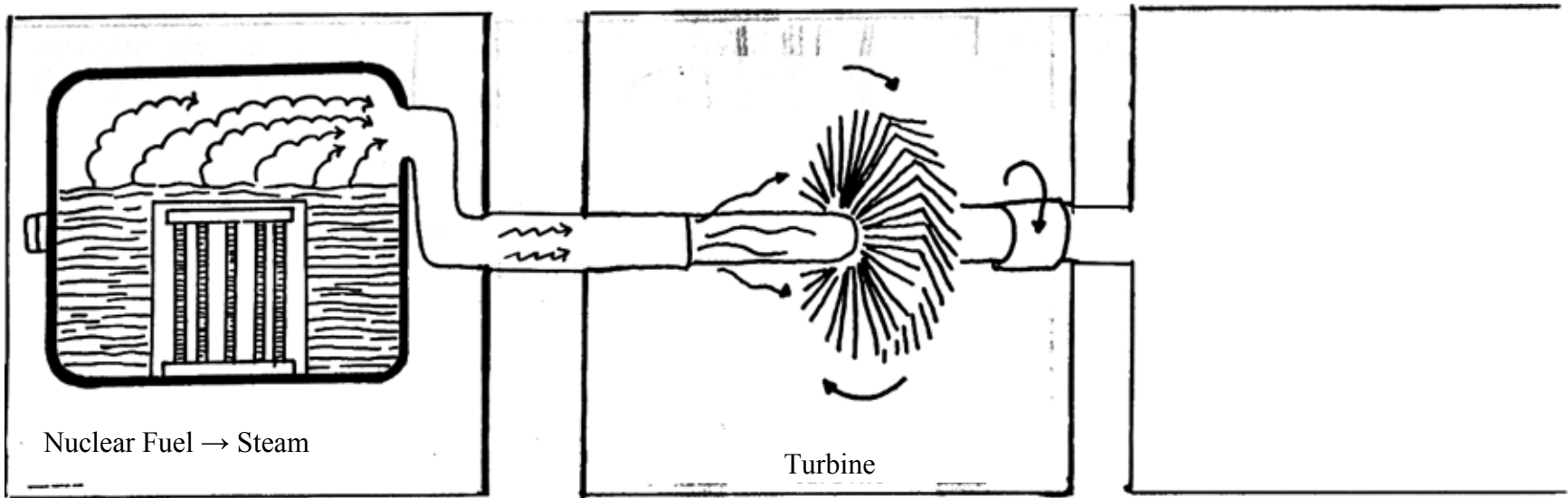

We can concentrate sunlight to make steam.

MAKE UP YOUR OWN!

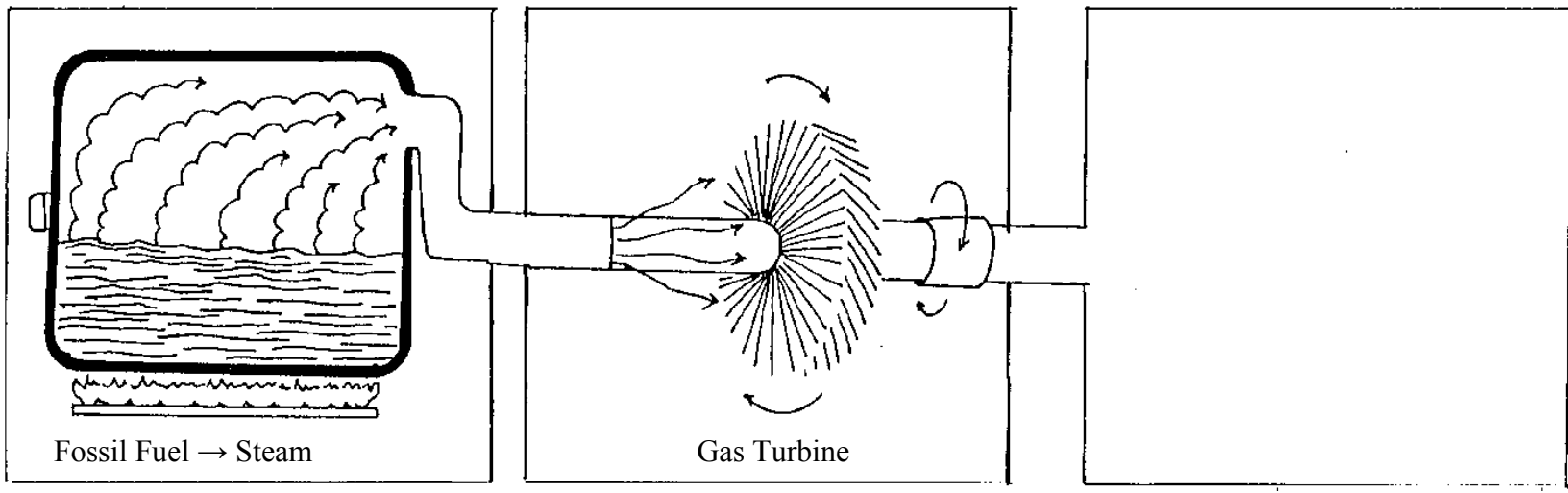
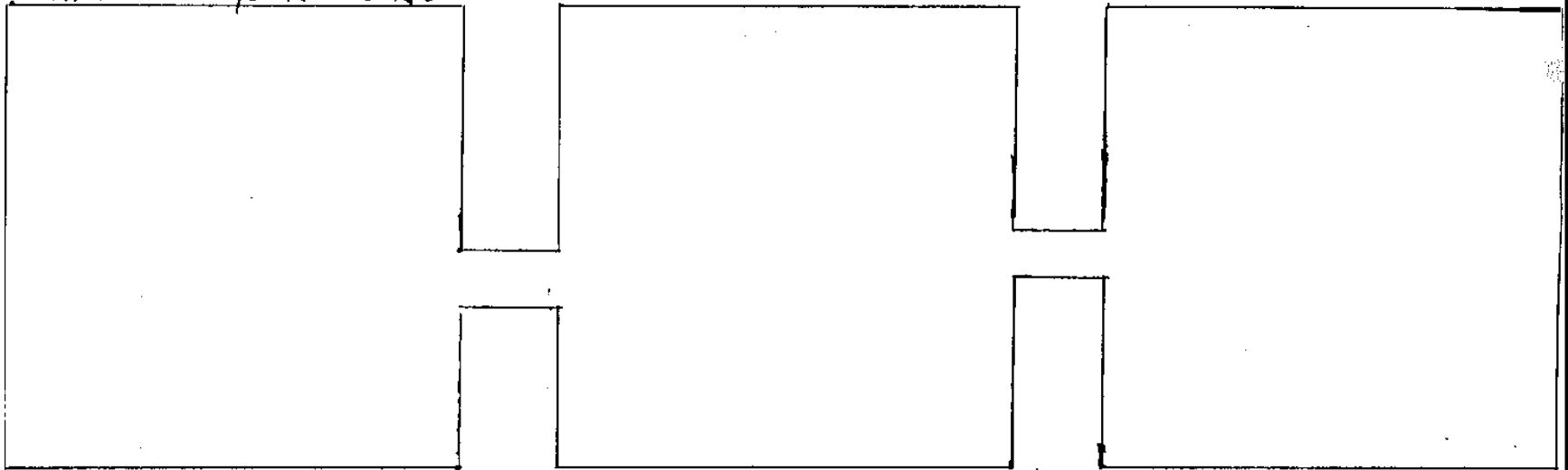

We burn coal, oil, or natural gas to make steam to produce 72% of our electricity.

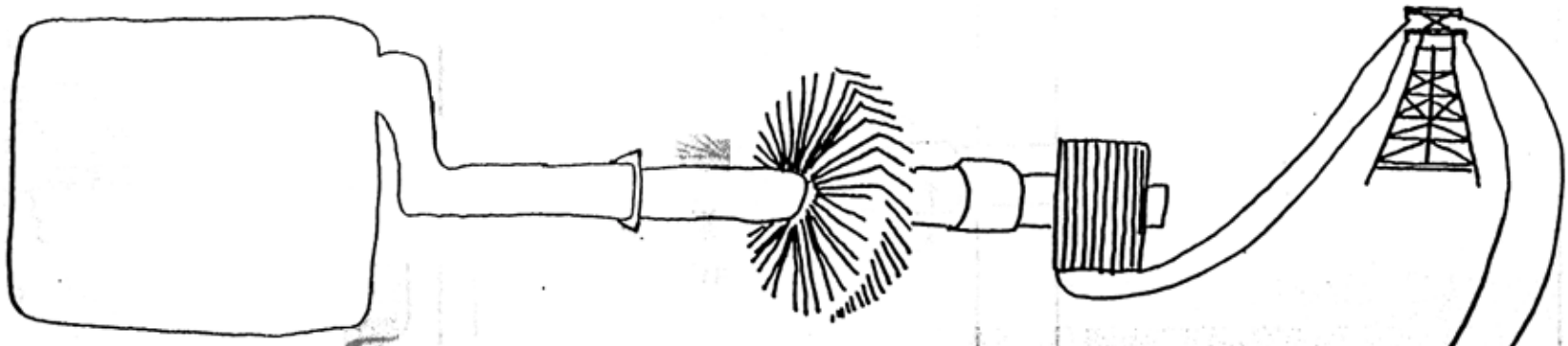

Draw the energy source used in our area.

- nuclear
- fossil fuel
- wind
- hydro
- geothermal
- solar

- A. most used in our area
- B. most expensive
- C. most efficient
- D. most dangerous
- E. most accessible
- F. greatest polluter
- G. most promising for the future

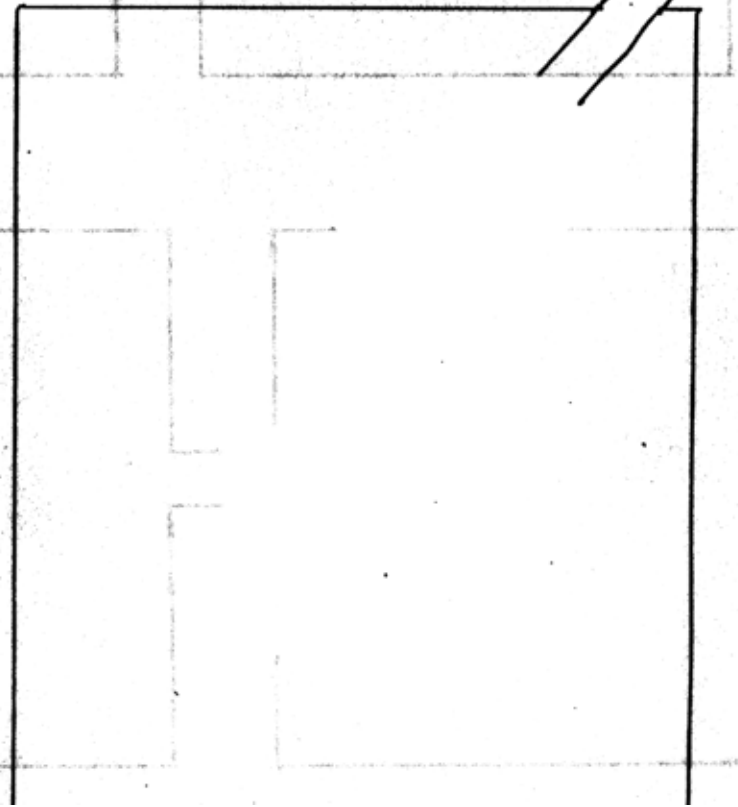

Renewable Energy: WIND AND WATER

**Activity 6: The Answer is Blowing in the
Wind**

**Activity 7: Hydropower—Building a
“Turbin-ator”**

Activity 6 THE ANSWER IS BLOWING IN THE WIND

CONCEPT Students will learn that rotors, blades and wind speed are factors that determine how much electricity can be generated by a windmill.

GOAL Students will make three modern wind machines and determine which factors affect how well they turn with the least amount of wind.

MATERIALS Refer to "How Much Wind is Needed to Turn a Modern Wind Machine?" and "How Can you Measure Wind Energy?"

HELPFUL HINTS USING TLM Invite: Ask students what windmills in Holland are used for? (Surprisingly, not for energy! They are used to grind grain.) Refer to the previous activity to remind students that electricity is generated from something turning the shaft of a turbine. (Students that built a windmill in the last activity can use it as one of their "modern" wind machines.) Discover. Create. Ask Questions: refer to "How Much Wind is Needed to Turn a Modern Wind Machine?"

ACTIVITY

Refer to "How Much Wind is Needed to Turn a Modern Wind Machine?"

HOW MUCH WIND IS NEEDED TO TURN A MODERN WIND MACHINE ?



MATERIALS:

- 1 balsa wood dowel, 3/16" x 35.5cm
- 2 coat hangers; 6 thumbtacks
- 3 pieces construction paper, 35.5cm x 1.25cm
- 3 corks; drill; glue; 4 wooden spools ← ask anyone who sews!
- 1 piece 1/2" balsa, 5cm x 10cm
- 1 empty 1 lb. salt box; tape
- Teacher's discretion → Hobby knife; 1 sheet balsa, 1/6" thick
- Magic marker, any color

Make these 3 modern wind machines.

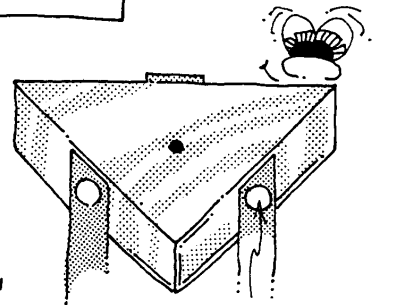
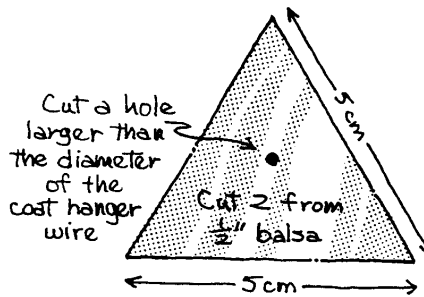

attach the 3 paper strips with thumbtacks

Helix Rotor

Cut salt box in half; tape together as shown.

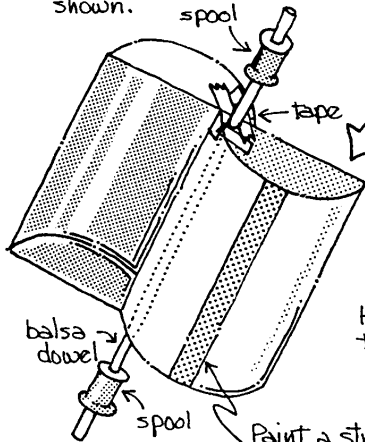

Savonius Rotor

Punch holes and insert balsa dowel.

Hold spools - let the rotor spin in the wind!

Paint a stripe of color here with a magic marker

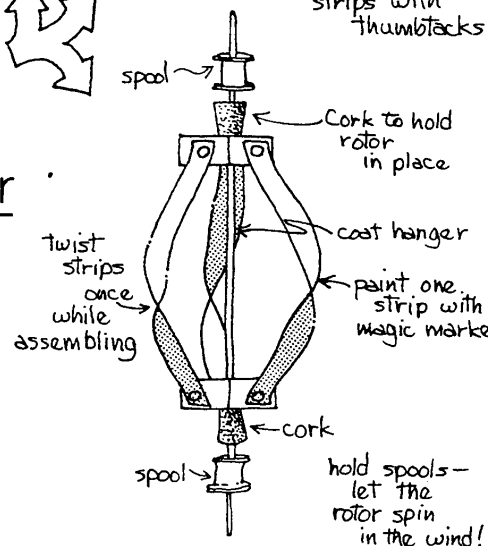

hold spools - let the rotor spin in the wind!

Conventional

Windmill

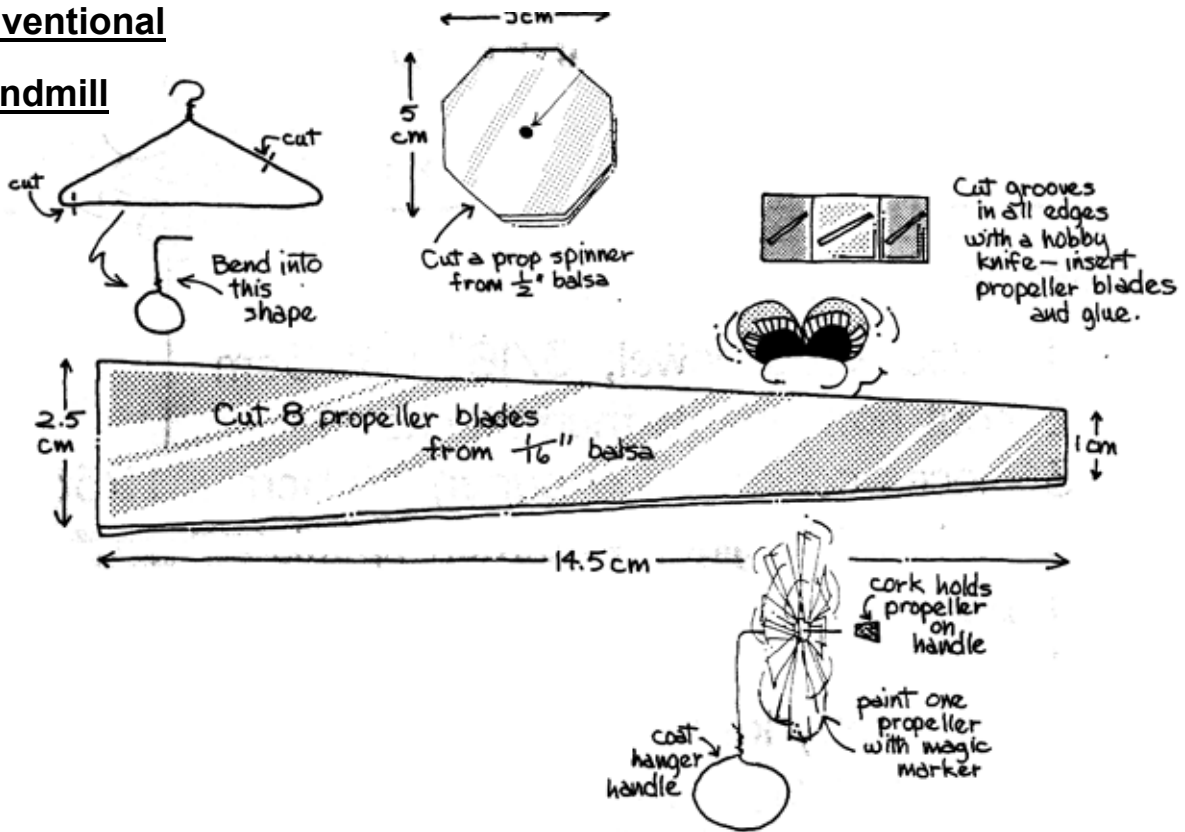

Face each of the wind machines into the wind. Use a wind measuring device to calibrate the wind speed. (See next page.)

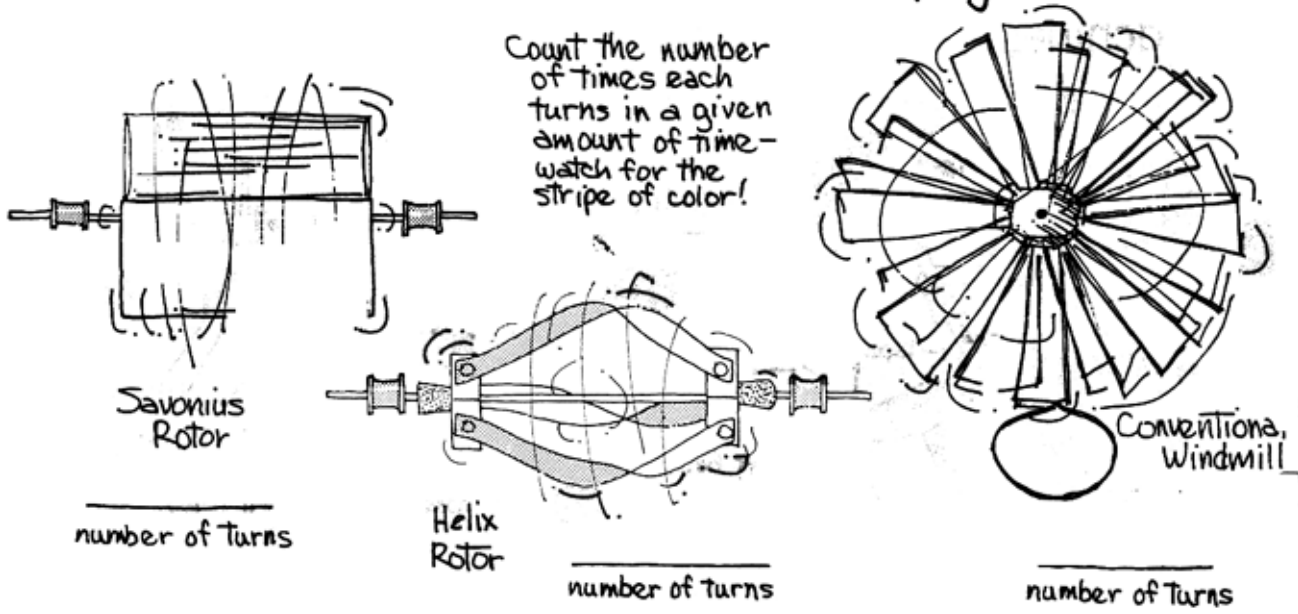

Which wind machine turns with the least wind?

How can you measure wind energy?

Some places have a lot of wind and others don't. For example, places that are higher or more open usually have stronger winds. Before you bought or built a windmill, you would want to be sure that your location had enough wind. But how can you measure the wind?

An anemometer is used to measure wind energy. You sometimes see them at airports.

You are going to make a simple anemometer and measure the wind energy around your school.

Materials for each anemometer:

pencil, pin, two soda straws, stapler, scissors, cone pattern, paper, tape, bottle with a narrow neck, stopwatch or watch with a second hand.

Steps

1. Staple 2 straws so they make an X. Reinforce with tape.
2. Cut out patterns for 4 cones. Color one cone red.
3. Staple one cone pattern to each straw end, so they all face the same way.
4. Curve each cone pattern to form a cone, and tape.
5. Pin the center of the X to the pencil eraser.
6. Insert the pencil in a narrow necked bottle, so that you can hold the bottle and the anemometer will spin freely.

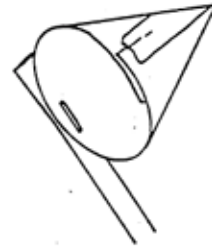
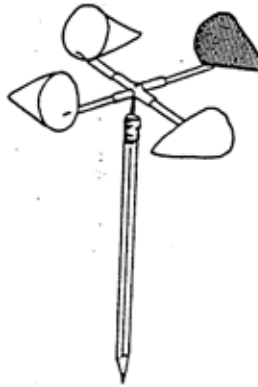
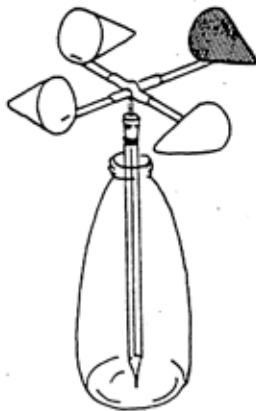
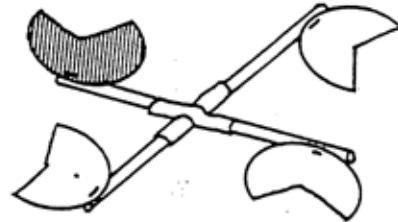
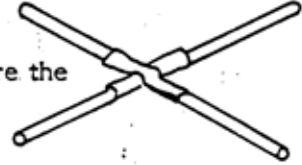

Activity 7 HYDROPOWER--BUILDING A "TURBIN-ATOR"

CONCEPT Students will learn that rotors, blades and water speed are also factors that determine how much electricity can be generated by hydropower (a dam).

GOAL Students will make a "hydro-mill" and design an experiment that measures the relationship between amount of water, speed, the number of turns of the rotor (turbine), and the weight of objects pulled in by the string. (Students should limit the variables listed above.)

MATERIALS Empty , clean 2-liter plastic soda bottle, scissors, tape, wood dowel, string, water, sink, "Hydro-Mill Experiment."

HELPFUL HINTS USING TLM Invite: Ask students to name some famous dams. Discuss how they produce electricity (turning the turbine!). Discuss the advantages and disadvantages of hydropower. Discover. Create. Ask Questions: see Activity below.

ACTIVITY

1. Assemble building materials and have students work independently or in small groups.
2. Construct the hydro-mill as follows:
 - A. Cut little doors length-wise into a plastic soda bottle and bend the doors open.
 - B. Insert a dowel into the neck of the bottle as an axle.
 - C. Fasten a string to the neck of the bottle. You can tie objects to the other end, and the mill pulls them in as the string rolls up. (This can also model the shaft of a turbine being turned.)
 - D. Using the sink, pour water over the mill to make it turn.
 - E. As a generic test, pour a fixed amount of water over the hydro-mill and measure the turns it makes. Students will need to experiment with the number of "doors" and their position.
3. Instruct students to design an experiment that measures any two factors relating to the hydro-mill. Use one factor as a constant, another as a variable. Hand out "Hydro-Mill Experiment" as a guide for students to use.

Name _____

HYDRO-MILL EXPERIMENT

Purpose: _____

Hypothesis: _____

Materials: _____

What You Did: _____

Results:

--

Conclusions: _____

New Questions: _____

Renewable Energy: BIOMASS

Activity 8: Which Has More Heat?

**Activity 9: Which Grass Produces More
Biomass?**

Activity 8 **WHICH HAS MORE HEAT?**

CONCEPT Students will learn that different types of fuel produce different amounts of heat energy.

GOAL Students will measure the amount of heat (calories) generated by a nonrenewable fuel (motor oil) and a renewable fuel (vegetable oil).

MATERIALS Refer to "Which Has More Heat Energy: Vegetable Oil or Petroleum Oil?"

HELPFUL HINTS USING TLM Invite: Ask students to name some fuels. Focus their attention of whether they come from renewable or nonrenewable energy sources. Ask how heat energy can be measured. Discuss vocabulary: calories, heat content. Discuss the use of thermometers and safety issues involved with burning substances. Discover. Create. Ask Questions: refer to "Which Has More Heat..."

ACTIVITY

Refer to "Which Has More Heat Energy: Vegetable Oil or Petroleum Oil?"

WHICH HAS MORE HEAT ENERGY: VEGETABLE OIL OR PETROLEUM OIL?

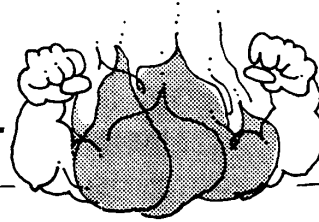

MATERIALS:

Vegetable oil; #20 or #30 automobile oil

2 Pieces cotton clothesline, 3 cm each

Glass eyedropper; thermometer

Teacher's Discretion

Matches; tin can; paper clips; metric measuring cup

Styrofoam cup; wire coat hanger or ring stand

Prepare your experiment like this.

Which do you guess has more heat energy?

Measure the temperature of the cold water and record. Light the oil on the clothesline and let the oil burn completely. Record the water temperature.

Run the experiment again using automobile oil. Record the water temperature and compare results.

Summary question:

Would vegetable oil be a good substitute for petroleum oil as fuel? Why?

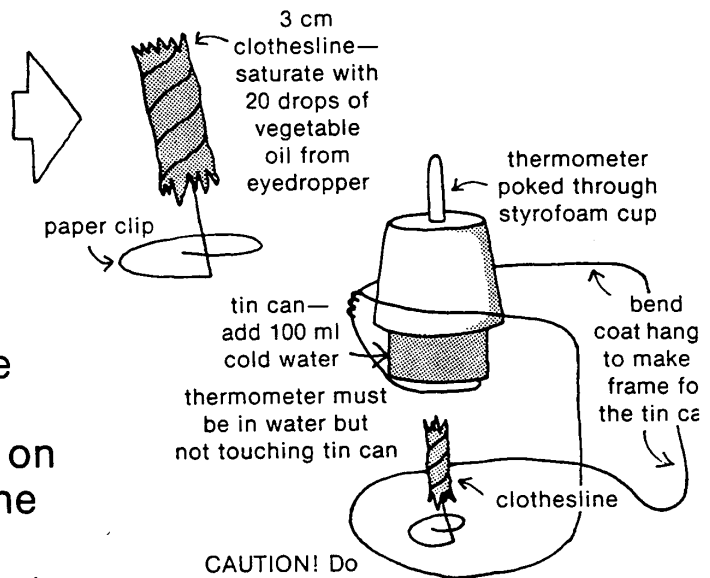

CAUTION! Do your experiment on a surface that won't burn!

		temperature of cold water	temperature after burning	difference in temperatures
oil tested	VEGETABLE OIL			
	AUTOMOBILE OIL			

OTHER IDEAS TO EXPLORE:

Try different kinds of oils (peanut, olive, safflower, etc.) to see if they have different heat contents.

Is there a difference in the heat content of solid animal fats (such as lard) and vegetable oil?

Where does the energy stored in the oils originally come from?

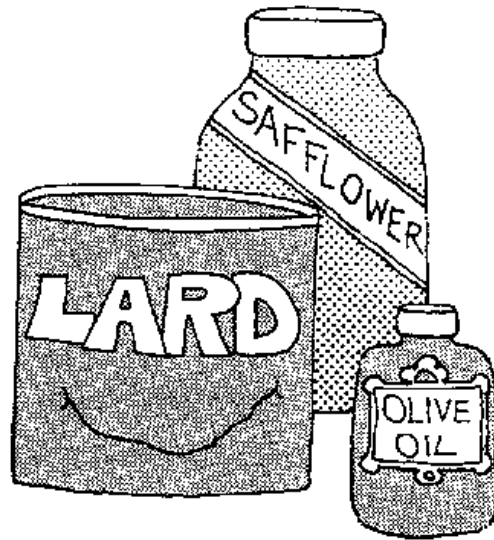

Activity 9 **WHICH GRASS PRODUCES MORE BIOMASS?**

CONCEPT Students will learn that different types of grasses produce different amounts of biomass.

GOAL Students will grow different types of grasses to determine which produces the most. Additionally, students will design an experiment to measure the amount of heat produced by each biomass sample.

MATERIALS Refer to "Which Grass Produces More Biomass in the Same Amount of Time?"

HELPFUL HINTS USING TLM Invite: Review the last activity and ask students about other types of renewable energy sources. Review how to measure heat content (calories) and ask them to predict which type of grass will produce the most heat. Also, discuss advantages and disadvantages to this energy source. Discover. Create. Ask Questions: Refer to "Which Grass Produces..."

ACTIVITY

Refer to "Which Grass Produces More Biomass in the Same Amount of Time?"

After 14 days pull the plants. Wash off the dirt and dry with a paper towel.

Weigh the plants and record. Dry the plants in the sun until they're crisp, and weigh them again.

		Weight	
		fresh weight	dry weight
Test plant	WHEAT or RYE		
	CORN		
	OATS		

Summary question:

Which plant is the best converter of light energy to biomass?

OTHER IDEAS TO EXPLORE:

Try burning the biomass produced. Set up and conduct your experiment as in Activity 8.



Would the results be better if your plants were allowed to mature?

Do other grasses produce more biomass? (Try using barley, triticale, rice, etc.)

What is done with most of the corn and wheat grown in this country? What might happen if a major portion of our grain was used to produce energy?

Renewable Energy: SOLAR ENERGY

**Activity 10: Solar Cell Power:
Series or Parallel?**

**Activity 11: Batch-Type Solar Collectors:
Which is Best?**

**Activity 12: Build a Better Solar
Greenhouse**

Activity 10 SOLAR CELL POWER: SERIES OR PARALLEL?

CONCEPT Students will learn that, in addition to turning the shaft of a turbine, electricity can be produced from a solar cell.

GOAL Students will use a solar cell to explore which type of electrical arrangement produces more power: series or parallel circuits.

MATERIALS Refer to "Which delivers more power to a motor: 2 solar cells in series or in parallel?" and "Converting Sunshine Into Electricity." (This is a 4-panel poster that can be reassembled to illustrate how a solar cell works.)

HELPFUL HINTS USING TLM Invite: Refer to Activity 5 and discuss what makes electricity. Show students an overhead made from "How a Solar Cell Works." Now that students are familiar with another way to generate electricity, ask if the arrangement of wires might make a difference in the amount of power from a solar cell. Discover. Create. Ask Questions: refer to "Which delivers more power..."

ACTIVITY

Refer to "Which delivers more power to a motor: 2 solar cells in series or in parallel?"

Which delivers more power to a motor, 2 solar cells in series or in parallel?

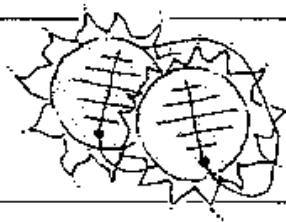

Materials

2 photocells, about .5 volts, 50-100 milliamps (local electronics hobby shop)

1 small motor, 1.5 volt, low-current type (available from the American Museum of Science & Energy)

1 Milliammeter, 0-500ma

1 Voltmeter, 0-1 volt

Rosin-core solder, fine (small diameter)

Small soldering iron

Black and red hookup wire (local electronics hobby shop or hardware store)

Note:
If the meter needle goes the wrong way, reverse the leads to the meter!

Wire the Solar Cell

First, wire the solar cells, unless wires are already attached.

Following the diagram below, wire the solar cells into a series circuit.

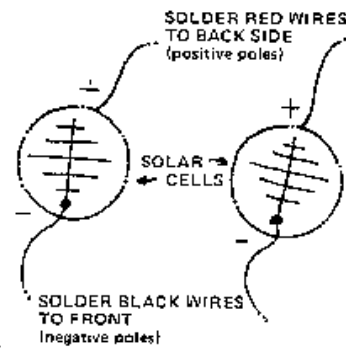

Place the solar cells in full sun and measure milliamps and volts.

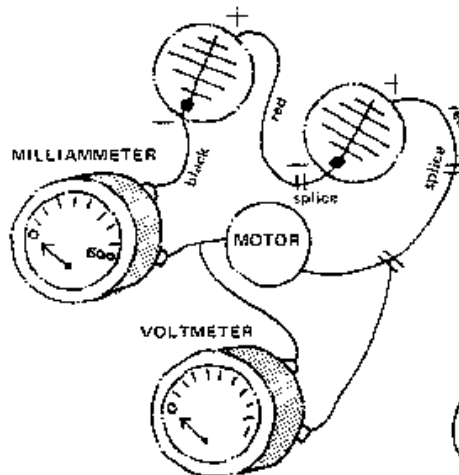

Compute the power generated:

$$\text{Power in watts} = \text{volts} \times \frac{\text{milliamps}}{1000}$$

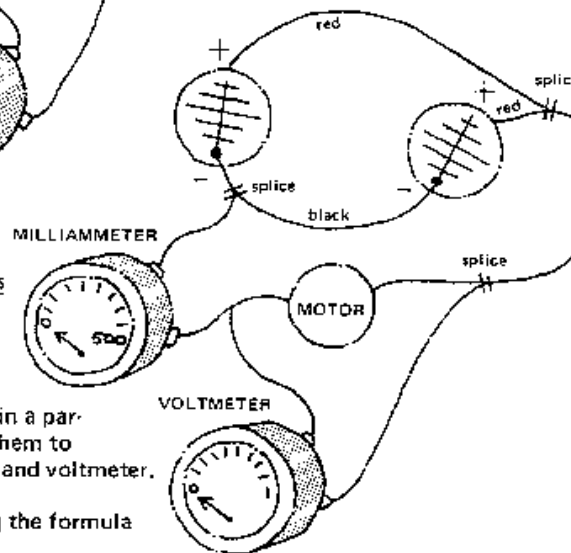

Reconnect the solar cells in a parallel circuit and connect them to the motor, milliammeter, and voltmeter.

Compute the power using the formula above.

Other Ideas to Explore

Would the results be the same if you wired a flashlight bulb instead of a motor into the circuits?

How much is the electricity you produced worth at the rates your local electric company charges?

How much would it cost to produce electricity for your home if you had to buy enough solar cells to do the job?

Solar Cells

Solar panels are made of many interconnected solar cells which convert sunlight into electricity; this is called a photovoltaic effect, or PV. The most common material in solar cells that causes the PV effect is silicon, the main substance in beach sand.

Imagine each cell has 6 layers. On top is a metal contact to conduct the electrical current. The second layer is an antireflective coating to allow sunlight to be absorbed instead of reflecting off. The third and fifth layers are mostly silicon, but the third layer is negatively charged and the fifth layer is positively charged. A barrier (the fourth layer) is formed where the negative and positive layers touch. The bottom layer is metal.

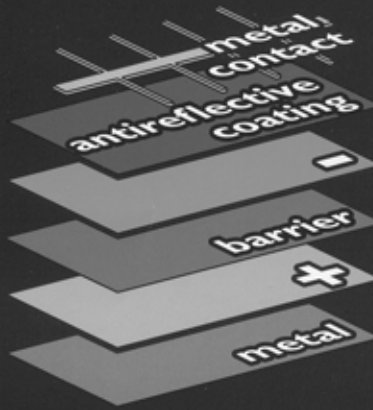

Solar cells would have no charge if they were made entirely of silicon. Each silicon atom has four valence electrons and forms a strong bond with its neighboring silicon atoms. However, phosphorous atoms are combined with the silicon in the third layer. Phosphorous has five valence electrons. (Electrons have a negative charge.) Because the extra phosphorous electrons have nothing to bond with, they add a negative charge to the layer. The fifth layer is given its charge by combining atoms of boron with the silicon. Since boron has only three valence electrons, one fewer than is needed, the layer has a positive charge.

Converting Sunlight into Electricity

95% of the sun's energy is released as sunlight. Without the sun, there would be no life on Earth as we know it.



g Sunshine Into

ppening Inside

motor

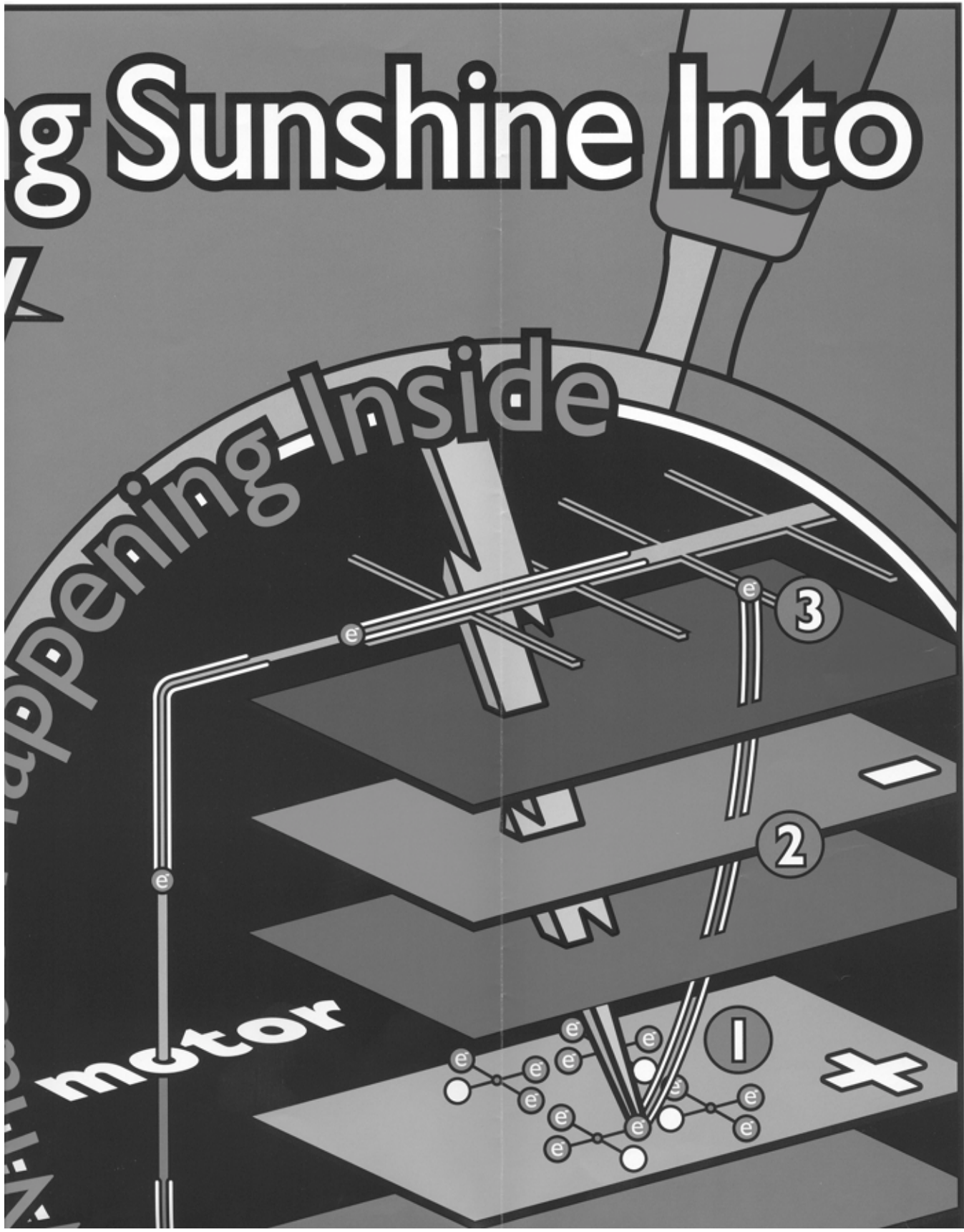

Panels and Systems

A typical solar cell measures 5 cm by 10 cm and produces about 3/4 of a watt of electricity. You can see that many solar cells are needed to power even one 60-watt light bulb.

For more power, solar cells are interconnected and placed within a solar panel. The panel also strengthens and protects the cells by encasing them in weather-proof materials such as glass or clear plastic. Although one panel provides enough power for some uses, two or more are connected for more power.

A complete solar energy system consists of panels and other components. The other components, called the Balance of System (BOS), include a structure on which the panels are mounted, wires that carry electricity to where it can be used, controls, and motors or storage devices, such as batteries.

It only takes 8 minutes for sunlight to travel from the sun to the surface of the earth. It travels as packets of energy called photons.

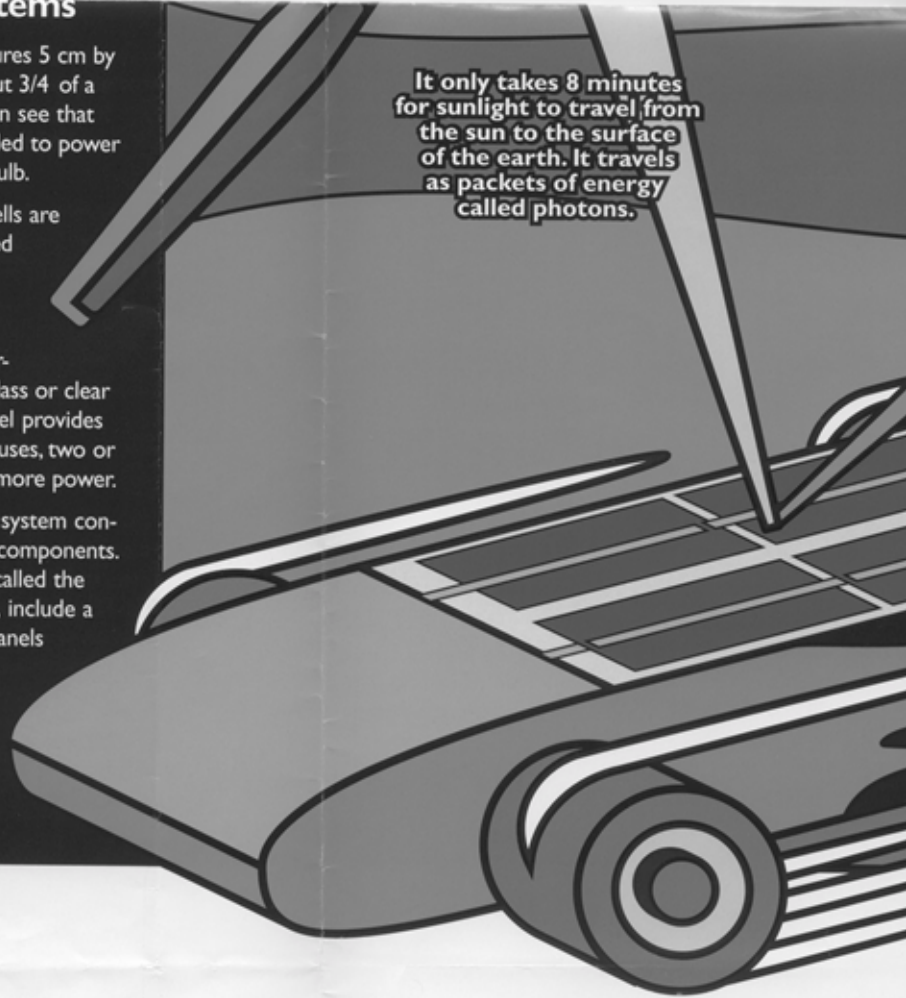

who discovered solar energy?

A PV effect was first noted in 1839 by a French physicist named Edmond Becquerel. He discovered that certain materials would produce small amounts of electric current when exposed to light. In 1905 Albert Einstein described the nature of light and the photoelectric effect on which PV technology is based. The first silicon PV cell was built by Bell Laboratories in 1954. In 1958 the U.S. Vanguard space satellite carried a small array of PV cells to power its radio. It worked so well that PVs have been part of the space program ever since.

Printed on recycled paper

why is solar energy better than fossil fuels?

If you use solar energy for your energy needs you will be adding to pollution and you won't run out of fuel. Solar panels have no moving parts to wear out, they can be used alone or in combination with other energy sources, they are silent, they are reliable and they last a very long time. In addition, sunshine is free.

A-S-E  **Americas, Inc.**
Billerica, Massachusetts

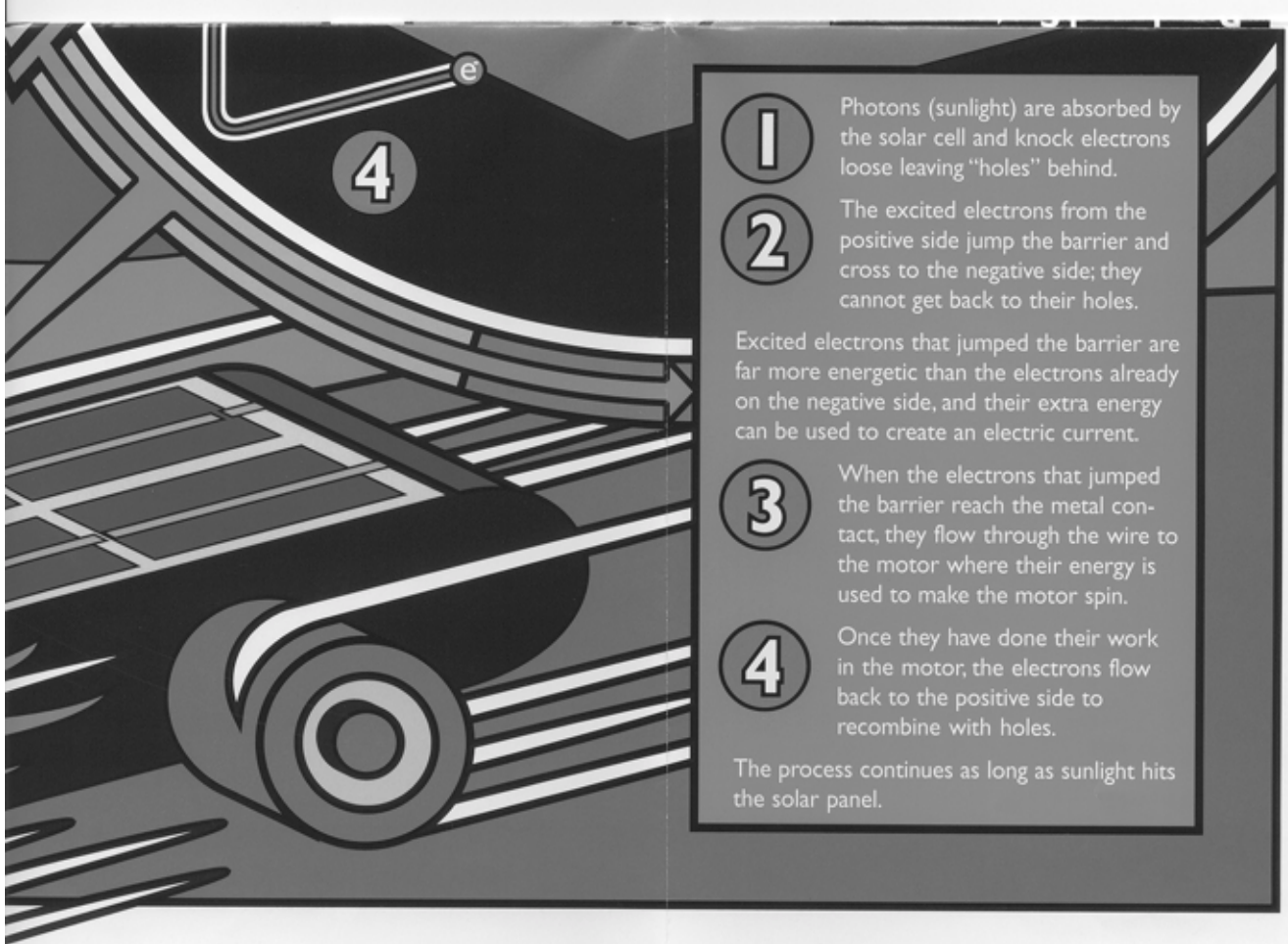

1

Photons (sunlight) are absorbed by the solar cell and knock electrons loose leaving "holes" behind.

2

The excited electrons from the positive side jump the barrier and cross to the negative side; they cannot get back to their holes.

3

When the electrons that jumped the barrier reach the metal contact, they flow through the wire to the motor where their energy is used to make the motor spin.

4

Once they have done their work in the motor, the electrons flow back to the positive side to recombine with holes.

The process continues as long as sunlight hits the solar panel.

Where are solar panels used now?

You are probably already using solar energy. Millions of small, hand-held calculators use solar panels. Solar energy is also used to power highway lighting, radios, portable TVs, Coast Guard buoys, lighthouses, traffic control signs, bus stop shelters, emergency communication systems, water pumps on cattle ranches, remote towns and villages that are not connected to power grids, and much, much more. Electric cars powered by solar energy are not far off. In 1994, a solar-powered car built by a Swiss university set a record speed of 51.3 mph.

Why isn't everything powered with solar energy?

PV energy has been in use for nearly 40 years. Until recently, however, it has been considered too expensive for large scale power generation. This is because the cost of providing electricity from large power plants that use conventional energy sources such as oil, gas and coal is less than the cost of solar panels. As PV technology advances and the price of solar panels decreases, solar energy is being used for more and more power needs. A few companies have been improving this technology for many years. One of them, ASE Americas, made the solar panel for the 1995 Junior Solar Sprint competition.

Activity 11 BATCH- TYPE SOLAR COLLECTORS: WHICH IS BEST?

CONCEPT Students will learn that there are several factors that determine the amount of heat energy absorbed by a batch-type solar collector.

GOAL Students will prepare three types of batch-type solar collectors and measure the temperature change caused by heat absorption. Students can then design their own experiment to create a batch-type solar collector that absorbs the most heat energy.

MATERIALS Refer to "Which batch-type solar collector gets the hottest after 15 minutes in the sun?"

HELPFUL HINTS USING TLM Invite: Review how solar cells work, then ask what other type of energy form comes from the sun besides electricity. Answer: heat. Ask what color of shirt you'd wear to stay cool at a baseball game on a hot summer day. Answer: white. Discuss why. Ask about ways to build a solar collector to maximize the amount of heat received using these concepts. Discover. Create. Ask Questions: refer to "Which batch-type solar collector..."

ACTIVITY

1. Refer to "Which batch-type solar collector gets the hottest after 15 minutes in the sun?"
2. Using the "Other Ideas to Explore" at the bottom on the attached activity, have students design their own experiment to determine at least one other factor besides color that results in more heat absorption.

Which batch-type solar collector gets the hottest after 15 minutes in the sun?

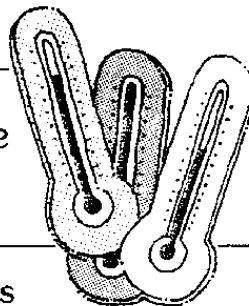

Materials

Plastic trash bags; one each white, green, and black (local grocery store)

Insulating material (styrofoam, cardboard, newspaper, etc.)

Aluminum foil

3 thermometers

Tape

Prepare the Collectors

Make 3 plastic trash bag solar collectors by following the drawing below. On the ground outside, put down insulating material, and then aluminum foil. The bags go on top in a row.

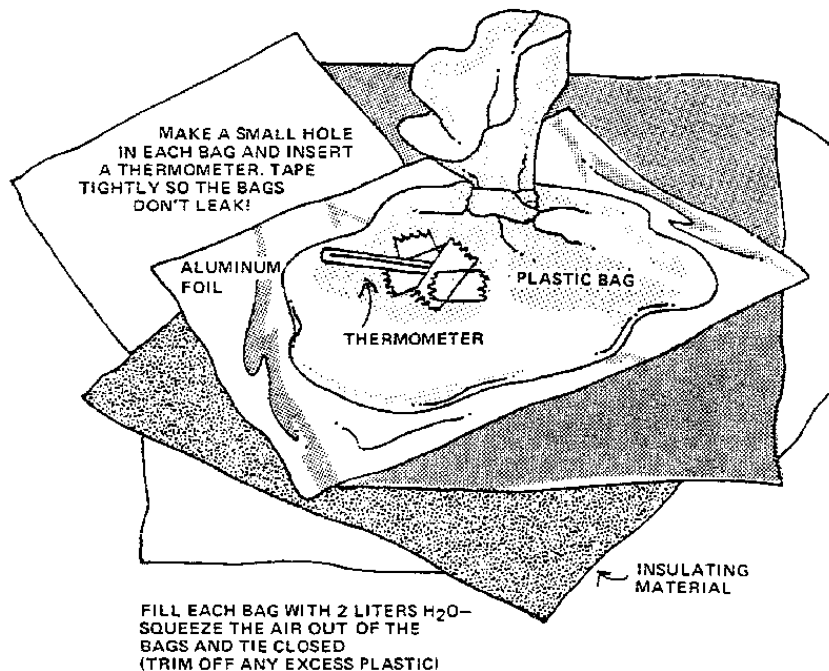

Record the temperatures of the 3 collectors, and place the collectors on the foil in the sun.

Record the temperatures again in 15 minutes.

What causes the differences in temperatures recorded?

How could this affect other solar experiments?

	TEMP. BEFORE	TEMP. AFTER
GREEN		
WHITE		
BLACK		

Other Ideas to Explore

Try this experiment with 2 bags of the same color. Prepare these solar collectors in the same way and place them in full sun, one on insulation material and foil and the other directly on the ground.

Record the temperatures as above and compare the results.

Activity 12 **BUILD A BETTER SOLAR GREENHOUSE**

CONCEPT Students will learn that there are several factors that help keep the temperature stable in a greenhouse.

GOAL Students will construct two greenhouses: one standard, the other solar. They will then determine which keeps a steadier temperature when placed in sunlight during the winter.

MATERIALS Refer to "How much better is a solar greenhouse than a standard greenhouse at keeping a steady temperature in the winter?"

HELPFUL HINTS USING TLM Invite: Ask students about the "Greenhouse Effect" and how it operates. Ask what conditions change how much heat is trapped inside? Refer to how a car feels when you get in it as it's been sitting in the sun on a cold day. Have students hypothesize which type of greenhouse will stabilize temperatures. Discover. Create. Ask New Questions: refer to "How much better is a solar greenhouse..."

ACTIVITY

Refer to "How much better is a solar greenhouse than a standard greenhouse at keeping a steady temperature in the winter?"

How much better is a solar greenhouse than a standard greenhouse at keeping a steady temperature in the winter?

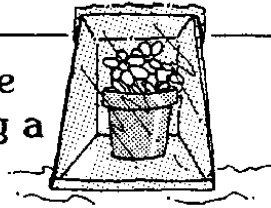

Materials

- Corrugated cardboard (figure amount needed based on drawings)
- Clear plastic, 3- or 4-mil, 50cm x 450cm (local hardware or garden stores)
- Flat black spray paint
- White spray paint
- 2 Thermometers
- Plastic wrap (grocery store)
- Tape
- String or thread
- Tin cans
- Rubber bands
- Insulation material (styrofoam, cardboard, newspaper, etc.)

Build a Solar Greenhouse

Build a solar greenhouse and a standard greenhouse according to these drawings. (Be sure to cut 2 of each side panel.)

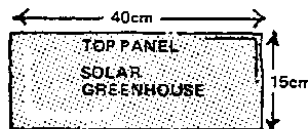
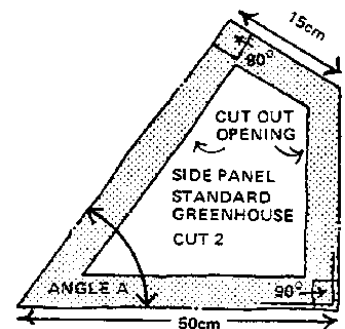
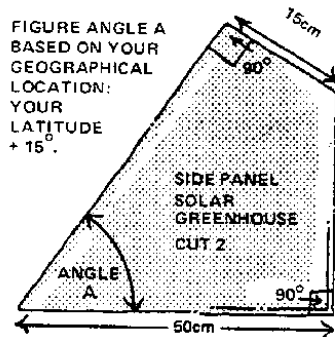
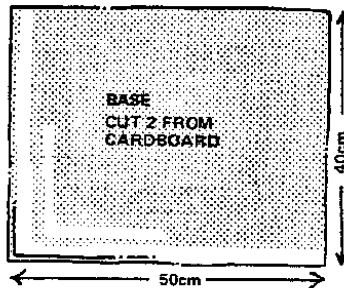

Spray the outside of the greenhouses white before adding plastic.

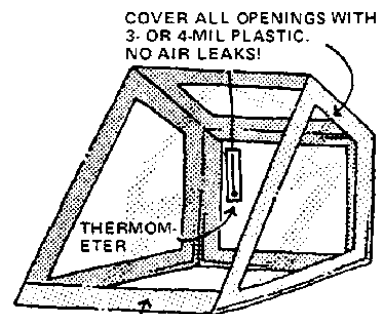
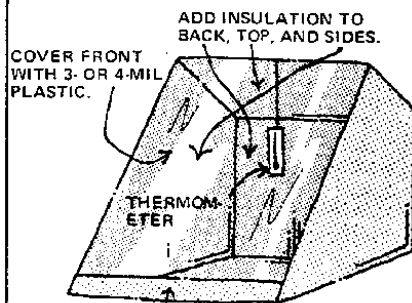

Add 5cm cardboard panel for stability.

Conduct Your Experiment Like This:

Face both greenhouses directly into the sun.

Measure and record the temperatures in each one as the day progresses.

After they have reached a high temperature place both in the shade—read and record the temperatures as they cool off.

Spray the cans flat black.
Fill with H₂O and cover tightly with plastic wrap and rubber bands.
Stack them in the back of the solar greenhouse.

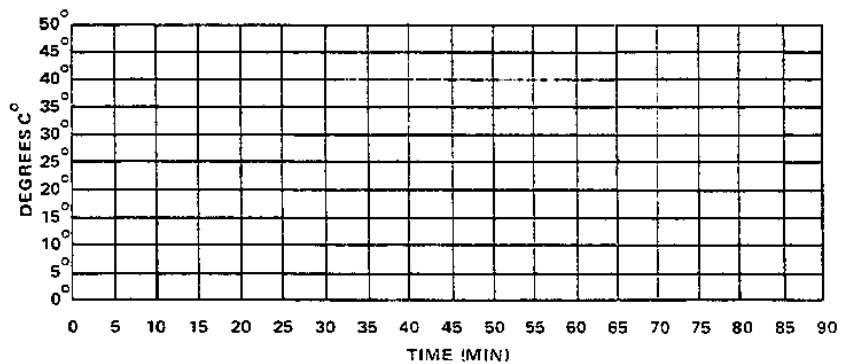
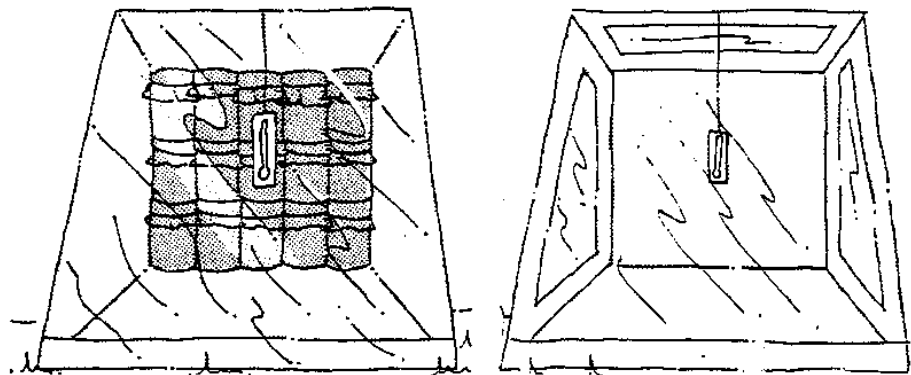
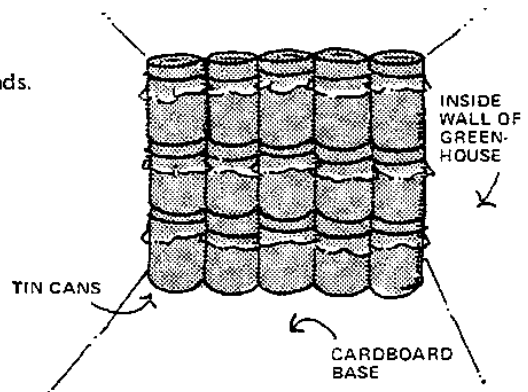

Graph the results of your experiment.

Other Ideas to Explore

What would happen if you added more insulation material? What if you added 2 layers of plastic to the front?

What are other ways of maintaining and storing heat when there is no sunlight?

Try substituting gravel, sand, and soil for H₂O in the tin cans in the solar greenhouse and try the experiment again.

Would you save energy in your climate by using a solar greenhouse?

REACT

Sample Rubric

The following sample rubric is designed to aid the teacher in developing suitable assessments for these activities. It is included only as a guide.

Rubric for Task Assessments

REACT

Activities for Middle Level Students

General Scale for Scoring Student Performance

SCORE	DESCRIPTION
4	Beyond expectations—quality of work is unusually high and beyond expectations
3	Meets expectation—skill is mastered to the level of expectation
2	Almost there—skill is almost mastered but with minor problems
1	The skill is present but with errors and omissions
0	The skill is absent